

Series MA-63

Type designation **MEM-M18NB/H11-K2**

Item number **6363863037**

Wiring diagram

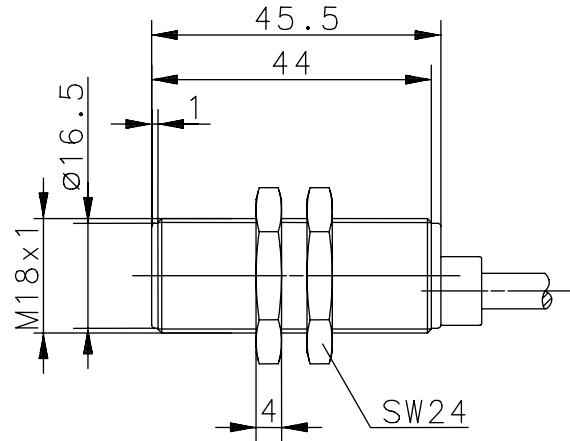
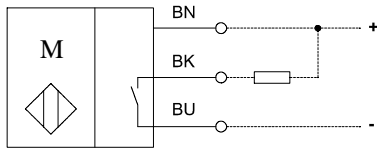

Characteristic features in accordance with EN 60947-5-2

Electrical data

Assured operating distance	S _a	17 mm
Switching function		NPN, open collector, bistable
Operational voltage range	U _B	4,5-24 VDC
Switching current		25 mA
Supply current		< 5 mA
Voltage drop	U _d	< 1 V
Switching element		Hall, typ. 11 mT, south on/ north off
Short-circuit protection		current limit
Frequency of operating cycles	f	20 kHz
Assembly position		optional
False polarity protection		yes
Corresponding magnet		T-62 N/S

Electromagnetic compatibility (EMC)

Electromagnetic field test	IEC 61000-4-3
Electrostatic discharge test	IEC 61000-4-2
Electrical fast transient immunity test (Burst)	IEC 61000-4-4
Radiated disturbance field strength	EN 55011

Mechanical Data

Enclosure	CUZn39Pb3
Front cap	PA6.6
Ambient air temperature	-25 °C ... +70 °C (cabel fixed mounted)
Type of protection	IP67 acc. to IEC 529, EN 60529
Termination type	cabel 3 x 0,14 mm ² x 2 m; PVC-Outer jacket, black
For attachment	2 x hexagon nut

EU Conformity



This document will not become the contractual basis; the details included herein do not constitute any descriptions of expected conditions, so that warranties/claims for defects on account of possible variations of the actual from the here described condition are excluded. Subject to modifications and amendments.

Date of issue: 14.05.2008 / Page 1 of 1
Document: 6363863037_en / Last update: 1 / 0144-08