



**TECHNICAL CHARACTERISTICS**

- Aluminium alloy construction
- Smooth operation
- High efficiency impeller
- Maintenance free
- Mountable in any position
- Recognized TEFC - cURus motor

**OPTIONS**

- Special voltages (IEC 38)
- Surface treatments

**ACCESSORIES**

- Inlet and/or inline filters
- Additional inlet/outlet silencers
- Safety valves
- Flow converting device
- Optional connectors

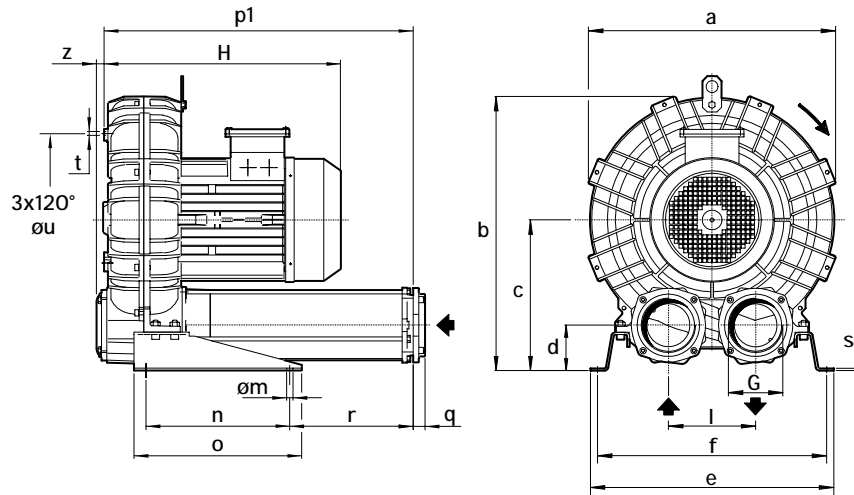

Dimensions in inches.  
Dimension for reference only.

Model	a	b	c	d	e	f	G	l	m	n	o	p1	q	r	s	t	u	z
K07R-MD	16.69	18.94	10.59	3.23	18.43	17.24	2" NPT	6.10	0.51	11.81	31.78	16.46	0.71	1.70	0.20	M8	11.61	0.63
K08R-MD	17.99	19.61	10.59	3.23	18.82	17.64	2" NPT	6.10	0.51	11.81	13.78	16.46	0.71	1.70	0.20	M8	12.20	0.63
K09-MD	19.37	22.09	12.40	3.78	20.00	18.82	4" NPT	7.17	0.51	11.81	13.78	25.35	0.98	10.12	0.20	M8	14.17	0.63
K10-MD	20.31	22.56	12.40	3.78	20.00	18.82	4" NPT	7.17	0.51	11.81	13.78	25.35	0.98	10.12	0.20	M8	14.17	0.63
K11-MD	21.35	23.74	13.07	3.58	21.18	20.00	4" NPT	7.87	0.51	11.81	13.78	25.75	0.98	10.31	0.20	M8	15.35	0.63
K12-MD	21.57	23.85	13.07	3.58	21.18	20.00	4" NPT	7.87	0.51	11.81	13.78	25.87	0.98	10.31	0.20	M8	15.35	0.62

Model	Maximum flow cfm		Installed power Hp		Maximum diff erential pressure Δp ( In Hg )		Noise level Lp dB (A) (1)		Overall dimensions H Inches	Weight Lbs
	60 Hz 3500 rpm	50 Hz 2900 rpm	60 Hz 3500 rpm	50 Hz 2900 rpm	60 Hz 3500 rpm	50 Hz 2900 rpm	60 Hz 3500 rpm	50 Hz 2900 rpm		
K07R-MD	129	107	5 1/2	5 1/2	11.8	13.3	74.5	72.5	16.30	117
			7 1/2	7 1/2	13.3	-	75.0	73.0	17.60	159
K08R-MD	168	139	5 1/2	5 1/2	7.4	11.8	76.2	74.2	16.30	125
			7 1/2	7 1/2	11.9	13.3	76.6	74.6	17.60	167
K09-MD	221	183	10	10	13.3	-	77.0	75.0	19.10	179
			10	10	14.0	11.8	79.5	77.5	19.50	210
K10-MD	275	228	10	10	9.6	12.6	80.3	78.3	19.50	214
			15	15	12.6	-	81.4	79.4	19.50	228
K11-MD	306	254	15	15	13.3	12.6	81.4	79.4	19.70	244
			15	15	7.4	12.6	82.3	80.3	19.90	242
K12-MD	336	278	20	20	12.6	-	82.6	80.6	22.50	278

(1) Noise measured at 1 m distance with inlet and outlet ports piped, in accordance to ISO 3744.

- For proper use, the blower should be equipped with inlet filter and safety valve; other accessories available on request.
- Ambient temperature from +5° to +104°F.
- Specifications subject to change without notice.



SCL K07R / K08R / K09 / K10 / K11 / K12

MD SERIES  
SN 1852-12B 2/2

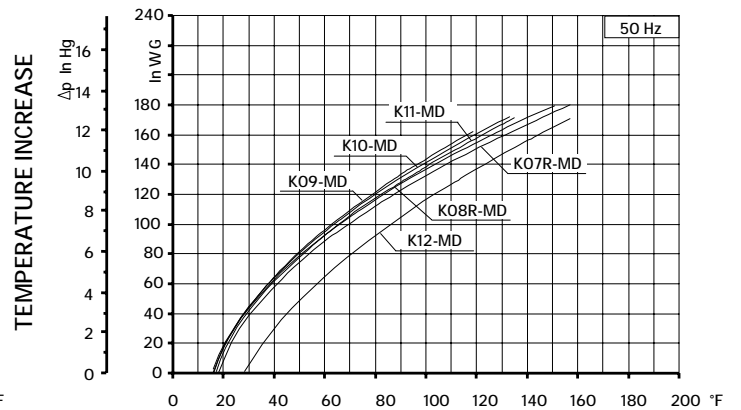
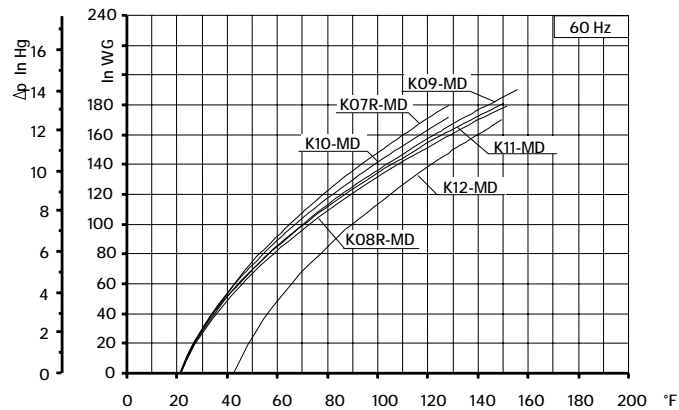
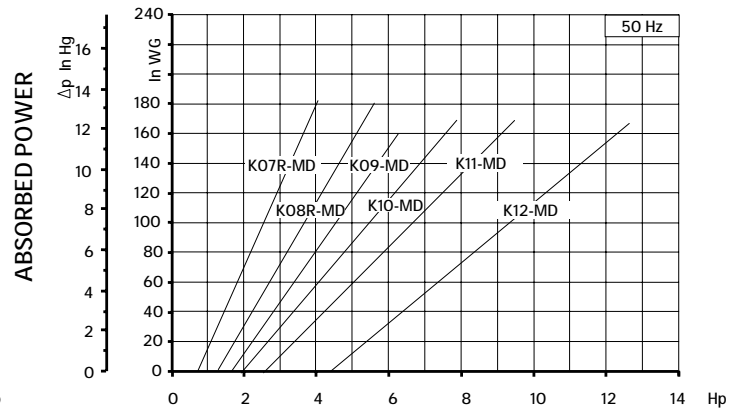
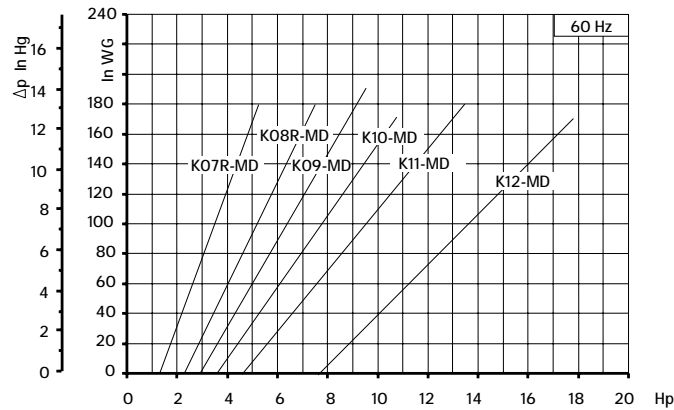
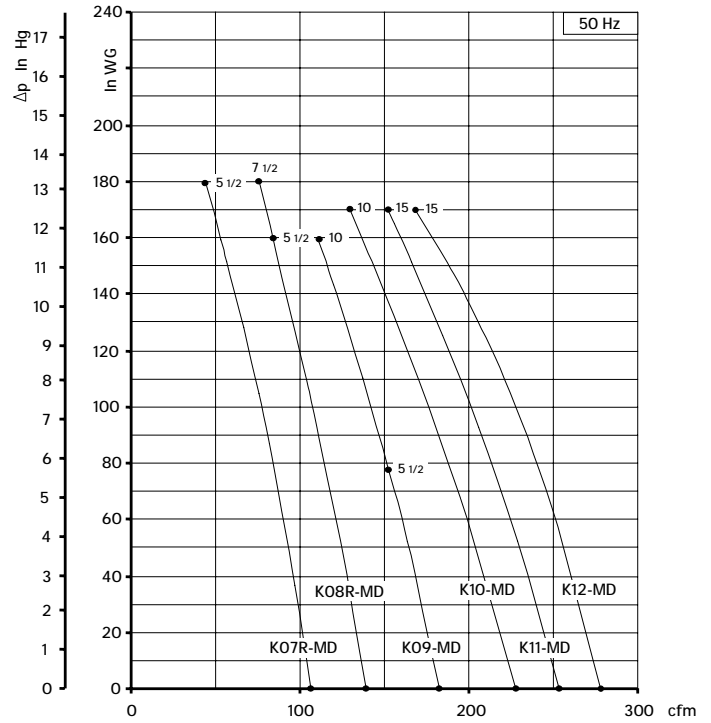
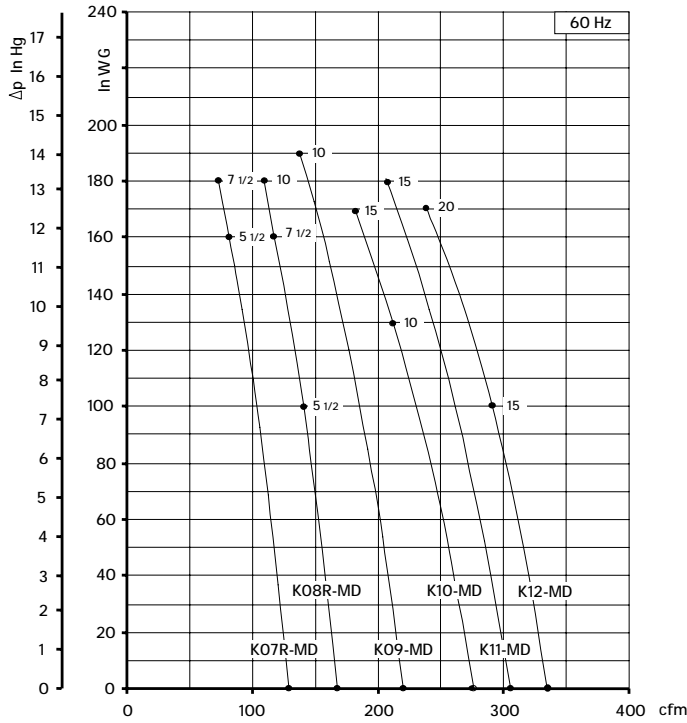

Curves refer to air at 68° F temperature, measured at inlet port and 29.92 In Hg atmospheric backpressure (abs).  
Values for flow, power consumption and temperature rise: +/-10% tolerance.  
Data subject to change without notice.