



TAKING THE RISK OUT OF TIGHTENING

2014



 DESIGNED & BUILT IN BRITAIN

www.torqueleader.com

Watch our Videos



Sign-up to receive our Newsletter



www.torqueleader.com



Follow us



on Twitter
@Torqueleader





Pour une meilleure compréhension de ces produits, merci de bien vouloir consulter notre site www.torqueleader.com et utiliser la fonction de Google translate Sur la page d'accueil



为便于您更好的用您的母语了解这些产品，请访问 www.torqueleader.com 并使用主页上的 Google translate 翻译功能



Hogy ezen termékeket jobban megértése az Ön nyelvén, legyen kedves látogasson el a www.torqueleader.com és válassza a Google translate funkciót a honlapon



Per una migliore comprensione di questi prodotti nella vostra lingua, visitare il sito www.torqueleader.com e utilizzare la funzione Google translate sulla home page



Für ein besseres Verständnis dieser Produkte in Ihrer Sprache, besuchen Sie bitte www.torqueleader.com und verwenden Sie die Google translate -Funktion auf der Startseite



Dla lepszego zrozumienia tych produktów w swoim języku, odwiedź www.torqueleader.com i skorzystaj z funkcji Google translate na stronie głównej



Para uma melhor compreensão destes produtos no seu idioma, por favor visite www.torqueleader.com e use a função Google translate no topo da página



あなたの言語でこれらの製品の理解を深めていただく為に、www.torqueleader.com のホームページ上の Google 翻訳機能をお使い下さい。



เพื่อความเข้าใจที่ดีขึ้นของผลิตภัณฑ์เหล่านี้ในภาษาของคุณ โปรดเข้าไปที่ www.torqueleader.com และใช้ ฟังก์ชันการแปลภาษา ของ Google translate ซึ่ง จะขึ้นอยู่บนหน้าหลักของเว็บ



Para una mejor comprensión de estos productos en su idioma, por favor visite www.torqueleader.com y use la función de traducción Google translate en la pagina principal



Для лучшего понимания этих продуктов на Вашем языке, пожалуйста, посетите www.torqueleader.com и использовать функцию Google translate на главной странице



“ For a better understanding of these products in your language, please visit www.torqueleader.com and use the Google translate function on the home page ”

Watch our Videos



Follow us on Twitter @Torqueleader

Sign-up to receive our Newsletter



www.torqueleader.com



Welcome to the 2014 Torqueleader catalogue, which has been designed to enable you to find products and information quickly.

The catalogue provides comprehensive information on our range of Torque Tools, Calibration & Repair Service and introduces the following new products to you:

- **Torcotronic Digital Wrench with Angle (see page 10)**

The addition of torque and angle measurement makes them suitable for an even wider range of applications



Torcotronic 120 with Angle



- **TLS PRESET DRIVERS (see pages 13 -16)**

We have redefined our range of Preset Torque Screwdrivers with 21st century ergonomics while retaining the quality, accuracy and durability that our reputation has been built on



Redefined Preset Torque Screwdrivers



CAPTURE

Sensor (see page 47)

Following the successful launch of the CAPTURE System in 2013 we have expanded our range of Sensors with the addition of CS 5, CS 25, CS 100 and CS 500 models



CAPTURE Sensors

We look forward to working with you in 2014 to ensure you have the right Torque Tool to meet your application.



Contents

Want to know more About Us,
our Tool Mechanisms or how to
use our Torque Tools...

Then watch our videos on
www.youtube.com/torqueleader

Watch our
Videos

YouTube
Broadcast Yourself™



Torque **Measuring** Tools



Torque **Applying** Tools



Torque **Calibration** Tools



Torque **Special** Projects



Torque **Accessories**



Technical Support



Want to know if you have the right tool for your Torque Application...

Tool Selector

Then use our Tool Selector at www.torqueleader.com/tool-selector



TAKING THE RISK OUT OF TIGHTENING

Sales Hotline +44 (0) 1483 894 476

- Determine the torque of an already tightened nut or bolt
- Used in Research and Development, Quality Auditing and Production Improvement

Page 5-10



- Apply a known torque. There are two main types - Calibrated Scale tools and Preset tools
- Used for Production Processes, Service and Repair

Page 11-42



- Check Torque Tools to ensure their accurate operation
- Used in Production Lines for daily tool checks and Calibration Laboratories for periodic tool calibration

Page 43-54



- Meet users' requirements and specifications
- Supplied either as Custom Manufactured Kits, Designed Tools or Private Labelling

Page 55-58



- Compatible with Torqueleader Wrenches and Screwdrivers

Page 59-68



- Information on our Services, Quality Assurance and Standards
- Guide to calculating correct torque settings

Page 69-75



Five easy ways to help you make the right choice...

- ✓ Use our Tool Selector at www.torqueleader.com/tool-selector
- ✓ Visit our Knowledge Centre at www.torqueleader.com/knowledge-centre
- ✓ Watch our YouTube videos at www.youtube.com/torqueleader
- ✓ Email us your enquiry at salesandrepairs@torqueleader.co.uk
- ✓ Call us on +44 (0) 1483 894 476 and speak to one of our Sales Team



Use our Tool Selector at www.torqueleader.com/tool-selector



Watch our YouTube videos at www.youtube.com/torqueleader

Introduction to Torque Measuring Tools



- Used to check torque settings in Research and Development, Inspection and Quality Control
- Used to apply torque in a Servicing or Production Environment



In this section...

- Explanation of the three types of Quality Auditing Tests
- Torque Screwdrivers with dial
- Torque Wrenches with dial or digital readout



Types of Measuring Tools

These tools have a **dial** or **digital readout** and can be a Torque Screwdriver or Torque Wrench design. They enable the operator to read either directly from the dial or readout as the torque is applied.

The torque can be measured as it is applied (**Track mode**) or the maximum torque value can be recorded (**Peak mode**).

Three Quality Auditing Tests

Marking Test... used to verify the torque of a previously tightened fastener. This is done by making a clear mark on the surface of the nut, bolt or screw and continuing the mark onto the surface being clamped. This acts as a reference point. The fastener must then be untightened and then retightened until the marks are again in line. The torque value can then be read from the torque tool display.

Just Move Test... used to determine the torque setting of a previously tightened fastener. Using a torque measuring tool, a tightening torque is applied to the fastener until movement is just seen or felt. This torque is deemed to be a good indication of the original torque applied to the fastener.

Break Loose Test... used for checking the torque applied to a previously tightened fastener. Torque is applied in the direction that loosens the fastener, at the point the fastener breaks loose, the torque is recorded. This value is an indication of the torque at which the fastener was originally tightened. This value is typically 20-30% lower than the tightening torque.



“Call **+44 (0) 1483 894 476**
to arrange a visit by one
of our Technical Managers”

For more information on...

- **Selecting the right tool** - Go to www.torqueleader.com/tool-selector
- **Using our tools** - Visit www.youtube.com/torqueleader
- **Price and availability** - Call our Sales Hotline **+44 (0) 1483 894 476**

TT Dial Measuring Torque Screwdrivers

Torque range from 0.1 to 5 N.m

Versatile tools perfect for any manufacturing environment

Want to know how to use this tool?



Watch our video

Industry Sectors

Maintenance & Repair

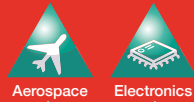

Quality Control



For Screwdriver Accessories... see pages 64-66 or visit www.torqueleader.com



TT 100 FH



Models also available in kgf.cm/kgf.m See www.torqueleader.com

T-Bar is not included with the TT Screwdriver Range



Key Benefits

- Process conformity can be ensured by the ability of these tools to carry out the **Just Move** and **Loosening Tests**, made simple by their unique memory function
- Low risk of tool damage is ensured by the overload protection system that uses a unique positive contact mechanism
- Minimise tool investment with these flexible tools, which can efficiently measure in Metric and Imperial torque units in both directions
- Peace of mind is provided by a long tool life backed by a two year warranty and fast comprehensive calibration service

Order now... call our Sales Hotline +44 (0) 1483 894 476

Order Code	Model	ISO	Calibrated Range			Drive	k mm	g	Accuracy	ISO 6789 Class
			ISO	Imperial	Imperial					
017000	TT 50 SD	10-50 cN.m	2 cN.m	14-70 ozf-in	2 ozf-in	1/4	178	190	+/- 6%	1D
017400	TT 50 FH	10-50 cN.m	2 cN.m	14-70 ozf-in	2 ozf-in	1/4	178	190	+/- 6%	1D
017100	TT 100 SD	20-100 cN.m	5 cN.m	28-140 ozf-in	5 ozf-in	1/4	178	190	+/- 6%	1D
017500	TT 100 FH	20-100 cN.m	5 cN.m	28-140 ozf-in	5 ozf-in	1/4	178	190	+/- 6%	1D
017200	TT 250 SD	50-250 cN.m	10 cN.m	4-20 lbf-in	0.5 lbf-in	1/4	250	465	+/- 6%	1D
017600	TT 250 FH	50-250 cN.m	10 cN.m	4-20 lbf-in	0.5 lbf-in	1/4	250	465	+/- 6%	1D
017300	TT 500 SD	100-500 cN.m	20 cN.m	8-40 lbf-in	1 lbf-in	1/4	250	465	+/- 6%	1D
017700	TT 500 FH	100-500 cN.m	20 cN.m	8-40 lbf-in	1 lbf-in	1/4	250	465	+/- 6%	1D



TT Screwdrivers have a long working life, two year warranty as standard and are easy to repair. Use our comprehensive **Calibration Service...** for more details visit www.torqueleader.com

Dial Measuring Torque Wrenches

Torque range from 0.8 to 2000 N.m

Robust and versatile tools for Quality Auditing and Production

Industry Sectors

Maintenance
& Repair



Aerospace



Military



Utilities

Quality
Control



Aerospace



Automotive



Packaging

For Special Extension Spanners ... see page 68
or visit www.torqueleader.com



BDS 80 E

ADS 25 S



Models also available in kgf.cm/kgf.m
See www.torqueleader.com



Durable storage case
for ADS and BDS models

Key Benefits

- These tools are suitable for use by operators of any skill level. The ease of use and robust design ensures years of dependable service
- Minimal risk of tool damage is ensured by the built in overload protection system
- Clockwise and anticlockwise measurement is possible with double ended ratchet as standard (except EDS versions)
- Clear indication is given when the target torque has been reached by the audio visual signal system (optional)



Calibrate your Dial Wrenches... visit www.torqueleader.com for more details
about our on site UKAS (United Kingdom Accreditation Service) Calibration Laboratory

Models...

ADS, BDS, CDS, DDS & EDS

Signal versions available. All ADS models are **EPA compliant**

Want to know how to use this tool?



Watch our video

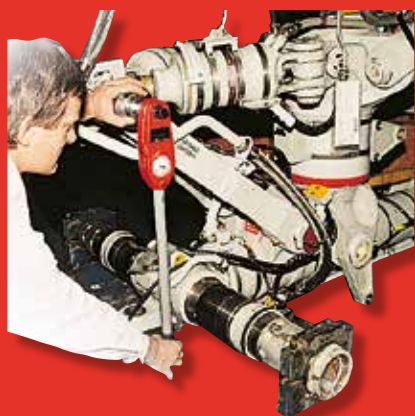

Order now... call our Sales Hotline +44 (0) 1483 894 476

Order Code	Model	ISO	Calibrated Range			Drive	k	mm	kg	Accuracy	ISO 6789 Class	Signal	
			ISO	Imperial	Imperial							ISO	ISO
010100	ADS 4	0.8-4.0 N.m	0.1 N.m	7-35 lbf-in	1 lbf-in	1/4	244	0.52	+/- 3%	1B	x	✓	
010108	ADS 4 S	0.8-4.0 N.m	0.1 N.m	7-35 lbf-in	1 lbf-in	1/4	244	0.52	+/- 3%	1B	✓	✓	
010120	ADS 8	1.6-8.0 N.m	0.25 N.m	14-75 lbf-in	1 lbf-in	1/4	244	0.52	+/- 3%	1B	x	✓	
010128	ADS 8 S	1.6-8.0 N.m	0.25 N.m	14-75 lbf-in	1 lbf-in	1/4	244	0.52	+/- 3%	1B	✓	✓	
010140	ADS 12 D	2.4-12 N.m	0.5 N.m	24-120 lbf-in	2 lbf-in	1/4	244	0.52	+/- 3%	1B	x	✓	
010148	ADS 12 DS	2.4-12 N.m	0.5 N.m	24-120 lbf-in	2 lbf-in	1/4	244	0.52	+/- 3%	1B	✓	✓	
010160	ADS 12 A	2.4-12 N.m	0.5 N.m	24-120 lbf-in	2 lbf-in	3/8	244	0.52	+/- 3%	1B	x	✓	
010168	ADS 12 AS	2.4-12 N.m	0.5 N.m	24-120 lbf-in	2 lbf-in	3/8	244	0.52	+/- 3%	1B	✓	✓	
010180	ADS 25	5-25 N.m	1 N.m	48-240 lbf-in	10 lbf-in	3/8	244	0.52	+/- 3%	1B	x	✓	
010188	ADS 25 S	5-25 N.m	1 N.m	48-240 lbf-in	10 lbf-in	3/8	244	0.52	+/- 3%	1B	✓	✓	
010200	ADS 25 F	5-25 N.m	1 N.m	4-20 lbf-ft	0.5 lbf-ft	3/8	244	0.52	+/- 3%	1B	x	✓	
010208	ADS 25 FS	5-25 N.m	1 N.m	4-20 lbf-ft	0.5 lbf-ft	3/8	244	0.52	+/- 3%	1B	✓	✓	
010220	ADS 40	8-40 N.m	1 N.m	72-360 lbf-in	10 lbf-in	3/8	244	0.52	+/- 3%	1B	x	✓	
010228	ADS 40 S	8-40 N.m	1 N.m	72-360 lbf-in	10 lbf-in	3/8	244	0.52	+/- 3%	1B	✓	✓	
010240	ADS 40 F	8-40 N.m	1 N.m	6-30 lbf-ft	1 lbf-ft	3/8	244	0.52	+/- 3%	1B	x	✓	
010248	ADS 40 FS	8-40 N.m	1 N.m	6-30 lbf-ft	1 lbf-ft	3/8	244	0.52	+/- 3%	1B	✓	✓	
010300	BDS 80 A	16-80 N.m	2 N.m	12-60 lbf-ft	1 lbf-ft	3/8	435	1.35	+/- 3%	1B	x	x	
010380	BDS 80 AS	16-80 N.m	2 N.m	12-60 lbf-ft	1 lbf-ft	3/8	440	1.47	+/- 3%	1B	✓	x	
010320	BDS 80 E	16-80 N.m	2 N.m	12-60 lbf-ft	1 lbf-ft	1/2	435	1.36	+/- 3%	1B	x	x	
010400	BDS 80 ES	16-80 N.m	2 N.m	12-60 lbf-ft	1 lbf-ft	1/2	440	1.49	+/- 3%	1B	✓	x	
010410	BDS 100 EF	20-100 N.m	2 N.m	14-70 lbf-ft	2 lbf-ft	1/2	515	1.41	+/- 3%	1B	x	x	
010415	BDS 100 E	20-100 N.m	2 N.m	168-840 lbf-in	24 lbf-in	1/2	515	1.41	+/- 3%	1B	x	x	
010340	BDS 160	32-160 N.m	2.5 N.m	24-120 lbf-ft	2 lbf-ft	1/2	515	1.41	+/- 3%	1B	x	x	
010420	BDS 160 S	32-160 N.m	2.5 N.m	24-120 lbf-ft	2 lbf-ft	1/2	520	1.54	+/- 3%	1B	✓	x	
010360	BDS 200	40-200 N.m	5 N.m	30-160 lbf-ft	5 lbf-ft	1/2	515	1.41	+/- 3%	1B	x	x	
010440	BDS 200 S	40-200 N.m	5 N.m	30-160 lbf-ft	5 lbf-ft	1/2	520	1.54	+/- 3%	1B	✓	x	
010520	CDS 400 S	80-400 N.m	10 N.m	60-300 lbf-ft	10 lbf-ft	3/4	710	3.20	+/- 3%	1B	✓	x	
010620	DDS 800 S	160-800 N.m	20 N.m	120-600 lbf-ft	20 lbf-ft	3/4	1000	4.90	+/- 3%	1B	✓	x	
010700	EDS 1400 S	280-1400 N.m	25 N.m	200-1000 lbf-ft	25 lbf-ft	1	2040	16.7	+/- 3%	1B	✓	x	
010720	EDS 2000 S	400-2000 N.m	50 N.m	300-1500 lbf-ft	50 lbf-ft	1	2040	16.7	+/- 3%	1B	✓	x	

Torcotronic Digital Torque Wrench with Angle

Torque range from 10 to 350 N.m

High accuracy tools with built in memory ideal for Quality Auditing and Production Applications

Want to know how to use this tool?



Watch our video

Industry Sectors

Maintenance & Repair



Automotive

Quality Control



Automotive



Consumer Products

For Sockets... see page 63 or visit www.torqueleader.com



Torcotronic 120 with Angle

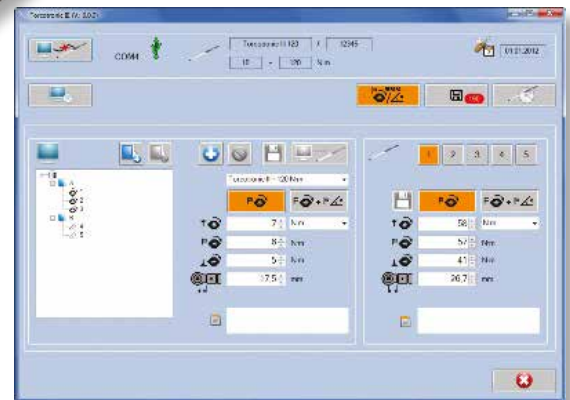

Data Analysis

Key Benefits

- These tools help minimise rework and warranty costs by giving confidence that the tightening process is under control through their high accuracy of +/-1% of reading between 10% and 100% of full scale
- Versatile tools which integrate with 9x12 and 14x18 wrench fittings. Supplied with reversible ratchet as standard
- These tools are fast and efficient to use as the memory stores the audit data ready for download to analysis software
- Process traceability is achieved by the historic data storage and management features of easy to use PC software available in 11 languages
- Suitable for a broad range of applications due to torque and angle capability plus 5 memory modes

Order now... call our Sales Hotline +44 (0) 1483 894 476

Order Code	Model	← Calibrated Range →		Drive	Adaptors	k mm	kg	ISO 6789 Class
		ISO	Imperial					
021640	120	10-120 N.m	7-88 lbf-ft	1/2	9x12	565	1.01	1C
021650	350	70-350 N.m	51-258 lbf-ft	1/2	14x18	701	1.18	1C



For your demonstration of the **Torcotronic** by one of our Technical Managers... call us now on +44 (0) 1483 894 476 or email salesandrepairs@torqueleader.co.uk

Introduction to Torque Applying Tools

- Used to apply a set torque to a fastener
- Will slip, break or click to signal to the operator when the set torque is reached



In this section...

- Explanation of the three different Torque Tool Mechanisms
- Preset tamperproof Screwdrivers and Wrenches
- Calibrated Scale Adjustable Screwdrivers and Wrenches

Types of Applying Tools

Preset Tools... ideal in environments that require the same torque to be applied to a fastener time after time. As these types of tools are tamper-proof they can be used by operators of any skill level. The tools must be set using a Calibration Analyser.

Calibrated Scale Tools... ideal for use in areas where a range of different torque settings need to be applied. These types of tools have a visible scale that allows the user to adjust them to their desired torque setting.

The principles underlying Torque Tool Mechanisms

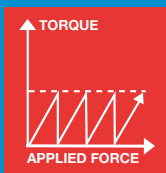

Slipping Tools...Overtightening Impossible

When the preset torque value is reached, (as indicated by the dotted line in the graph) a mechanism in these tools cause the application of torque to cease and the tools slip free.

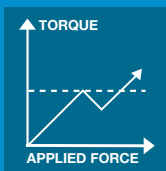

Breaking Tools...Overtightening Unlikely

When the preset torque value is reached, (as indicated by the dotted line in the graph) these tools break at a specific point along their length. The movement is approximately 20°.

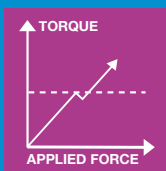

Clicking Tools...Overtightening Possible

When the preset torque value is reached, (as indicated by the dotted line in the graph) the operator will hear a click and feel an impulse. The movement is approximately 3°.



“ Watch our Slip, Break & Click Mechanism video on www.youtube.com/torqueleader ”

For more information on...

- **Selecting the right tool** - Go to www.torqueleader.com/tool-selector
- **Using our tools** - Visit www.youtube.com/torqueleader
- **Price and availability** - Call our Sales Hotline +44 (0) 1483 894 476



Torque range from 0.05 to 13.5 N.m

Redefined Preset Torque Screwdrivers

Want to know how to use this tool?



Watch our video

Industry Sectors

Manufacturing



Automotive



Electronics



Military



Consumer Products

More information on EPA compliant versions see page 15 or visit www.torqueleader.com

Slipping Mechanism

Incorrect tightening is impossible



- Ergonomic design
- Quality
- Accuracy
- Durability



Key Benefits

- Accurate process control is ensured by eliminating under and over tightening due to the proven Torqueleader slipping technology
- Years of dependable service is provided by the robust design especially if regularly calibrated
- Calibration stickers can be easily applied to the purpose designed nose
- Increased production efficiency by reducing operator fatigue due to an ergonomic hand grip combined with a smooth tool reset action
- The 1/4" female hexagon TLS range proves versatile with a quick conversion to male square 1/4" drive by using a convertor (Order Code: **029200**)



Models in this range... Pro, ESD & Prime

Also available are One Way (O/W) clockwise torque and anti clockwise torque for Pro and ESD plus Clean Room (CRS) Class 100 versions

For order details... See pages 14-17



Different colour end caps available (**Pro & ESD Screwdrivers** only) to allow for easy identification of which tool is set to which torque value - see **pages 14-15** for details

Torque range from 0.05 to 13.5 N.m

Pro Preset Torque Screwdrivers

Want to know how to use this tool?



Watch our video

For Bits & Blades... see pages 64-66 or visit www.torqueleader.com



Pro 25 & 150



Pro 450 & 1350

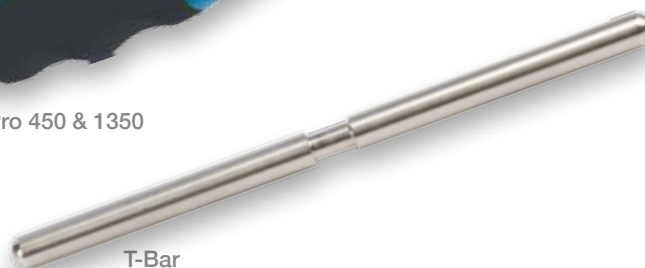

T-Bar



Key Benefits

- In addition to the main bullets on **page 13** the Pro 450 and 1350 models come with T-Bars as standard to assist with higher torque
- To allow for customisation and clear identification interchangeable coloured end caps are available in packs of four (Order Code: **065800**)

Order now... call our Sales Hotline +44 (0) 1483 894 476

Order Code	Model	Range		Drive	k mm	g	Repeatability	ISO 6789 Class	T-Bar
		ISO	Imperial						
065400	Pro 25 FH	0.05 - 0.25 N.m	0.45 - 2.2 lbf.in	$\frac{1}{4}$	132	210	+/- 6%	2F	✗
065410	Pro 25 FH O/W	0.05 - 0.25 N.m	0.45 - 2.2 lbf.in	$\frac{1}{4}$	132	224	+/- 6%	2F	✗
065500	Pro 150 FH	0.2 - 1.5 N.m	1.8 - 13 lbf.in	$\frac{1}{4}$	132	210	+/- 6%	2F	✗
065510	Pro 150 FH O/W	0.2 - 1.5 N.m	1.8 - 13 lbf.in	$\frac{1}{4}$	132	224	+/- 6%	2F	✗
065600	Pro 450 FH	0.5 - 4.5 N.m	4.5 - 40 lbf.in	$\frac{1}{4}$	140	230	+/- 6%	2F	✓
065610	Pro 450 FH O/W	0.5 - 4.5 N.m	4.5 - 40 lbf.in	$\frac{1}{4}$	140	245	+/- 6%	2F	✓
065700	Pro 1350 FH	2.5 - 13.5 N.m	22 - 120 lbf.in	$\frac{1}{4}$	140	230	+/- 6%	2F	✓
065710	Pro 1350 FH O/W	2.5 - 13.5 N.m	22 - 120 lbf.in	$\frac{1}{4}$	140	245	+/- 6%	2F	✓



Torqueleader offers a **Tool Presetting Service...** for more details please contact us on +44 (0) 1483 894 476 to talk to one of our Sales Team

Torque range from 0.05 to 13.5 N.m

ESD Preset Torque Screwdrivers

Want to know how to use this tool?



Watch our video

For Bits & Blades... see pages 64-66 or visit www.torqueleader.com



ESD 25 & 150



ESD 450 & 1350



T-Bar



Key Benefits

- ▶ In addition to the main bullets on **page 13** the ESD 450 and 1350 models come with T-Bars as standard to assist with higher torque
- ▶ To allow for customisation and clear identification interchangeable coloured end caps are available in packs of four (Order Code: **065800**)
- ▶ ESD models are ideal for safe electronic component assembly as these are **EPA compliant**

Order now... call our Sales Hotline +44 (0) 1483 894 476

Order Code	Model	Range		Drive	k mm	g	Repeatability	ISO 6789 Class	T-Bar
		ISO	Imperial						
065405	ESD 25 FH	0.05 - 0.25 N.m	0.45 - 2.2 lbf.in		132	210	+/- 6%	2F	X
065415	ESD 25 FH O/W	0.05 - 0.25 N.m	0.45 - 2.2 lbf.in		132	224	+/- 6%	2F	X
065505	ESD 150 FH	0.2 - 1.5 N.m	1.8 - 13 lbf.in		132	210	+/- 6%	2F	X
065515	ESD 150 FH O/W	0.2 - 1.5 N.m	1.8 - 13 lbf.in		132	224	+/- 6%	2F	X
065605	ESD 450 FH	0.5 - 4.5 N.m	4.5 - 40 lbf.in		140	230	+/- 6%	2F	✓
065615	ESD 450 FH O/W	0.5 - 4.5 N.m	4.5 - 40 lbf.in		140	245	+/- 6%	2F	✓
065705	ESD 1350 FH	2.5 - 13.5 N.m	22 - 120 lbf.in		140	230	+/- 6%	2F	✓
065715	ESD 1350 FH O/W	2.5 - 13.5 N.m	22 - 120 lbf.in		140	245	+/- 6%	2F	✓



TLS Screwdrivers can be customised to your exacting requirements... why not discuss your options with us by calling now on **+44 (0) 1483 894 476**

Torque range from 0.2 to 4.5 N.m

Prime Preset Torque Screwdrivers

Want to know how to use this tool?



Watch our video

For Bits & Blades... see pages 64-66 or visit www.torqueleader.com



Prime 150



Prime 450



Key Benefits

- Prime is equally suited to undoing fasteners due to its One Way (O/W) action as standard
- Ideal for one off applications due to its competitive pricing. For more details contact the Sales Team on **+44 (0) 1483 894 476**

Order now... call our Sales Hotline **+44 (0) 1483 894 476**

Order Code	Model	Range		Drive	k mm	g	Repeatability
		ISO	Imperial				
O65100	Prime 150 FH	0.2 - 1.5 N.m	1.8 - 13 lbf.in		138	198	+/- 10%
O65200	Prime 450 FH	0.5 - 4.5 N.m	4.5 - 40 lbf.in		138	198	+/- 10%



Torqueleader sell a comprehensive range of Accessories, Bits & Blades for TLS Screwdrivers...see pages 64-66 or visit www.torqueleader.com for details

TLS Preset Clean Room Torque Screwdrivers

Torque range from 0.04 to 13.6 N.m

Clean Room (CRS) Class 100

Want to know how to use this tool?



Watch our video

Industry Sectors

Manufacturing



Automotive



Electronics



Military



Consumer Products

Slipping Mechanism

Incorrect tightening is impossible



CRS 100-0022 FH



Key Benefits

- These tools are designed to protect precision products from contamination during assembly. They are designed specifically for use in **Clean Rooms** by utilising suitable surface treatments and incorporating high performance seals in their design
- Operator fatigue is minimised by the soft reset action of the tool
- Complete control of the tightening process is achieved by eliminating both under and over tightening as these tools incorporate Torqueleader's slipping mechanism
- Suitable for use by operators of any skill level, as these tools will repeatedly deliver the set torque without the need for operator intervention due to the tamper-proof design

Order now... call our Sales Hotline +44 (0) 1483 894 476

Order Code	Model	Range		Drive	k mm	g	Repeatability	ISO 6789 Class	Colour
		ISO	Imperial						
015089	CRS 100-0022 FH	4-22 cN.m	6-32 ozf-in		104	072	+/- 6%	2F	Grey
015209	CRS 100-0135 FH	10-135 cN.m	0.9-12 lbf-in		111	210	+/- 6%	2F	Grey
015609	CRS 100-0406 FH	50-400 cN.m	4.4-36 lbf-in		127	280	+/- 6%	2F	Grey
015939	CRS 100-1360 FH	2.5-13.6 N.m	22-120 lbf-in		137	325	+/- 6%	2F	Grey



CRS Torque Screwdrivers are preset type torque tools. They must be set to the required value by using a **Torque Analyser**... see pages 45-52 for details

ESD Electric Torque Screwdrivers

Torque range from 0.05 to 4.40 N.m

Ideal for use in high volume production environments

Industry Sectors

Manufacturing



Automotive



Electronics



Utilities



Consumer Products

For Accessories... call +44 (0) 1483 894 476
or visit www.torqueleader.com



EF 120



K 450

STC 30+ Controller



Key Benefits

- Maximises productivity by keeping downtime to a minimum, these tools are designed to last as they are constructed from durable robust materials
- Allows the operator to work effectively and safely as these tools are comfortable to use due to their ergonomic design. This can be further enhanced by pairing the driver with a tool weight balancer or torque reaction arm
- The EF and K series drivers help minimise rework and scrap by delivering controlled repeatable torque through features like 'slow start' mode which minimises cross threading
- Ensures the quality of plastic assembly tightening by combating joint relaxation through use of the 'double hit' repeat torque mode



Set and calibrate your Screwdriver with an **ET-cal II Compact Torque Calibration Analyser...**
for more details see **page 50** or visit www.torqueleader.com

Models...

EF 120 & K 450 Series

To be used in conjunction with STC 30+ Controller
(Order Code: **090000**)

Want to know how to use this tool?



Watch our video



Details of Power Bits... see page 64 or visit www.torqueleader.com

- ▶ Become productive quickly as these tools are simple to set up, requiring minimal operator training due to their easy to use design
- ▶ Maximises the production yields of electronic assemblies as these tools protect the assembly from static shocks due to their **ESD compliance**

Torque Reference Graphs

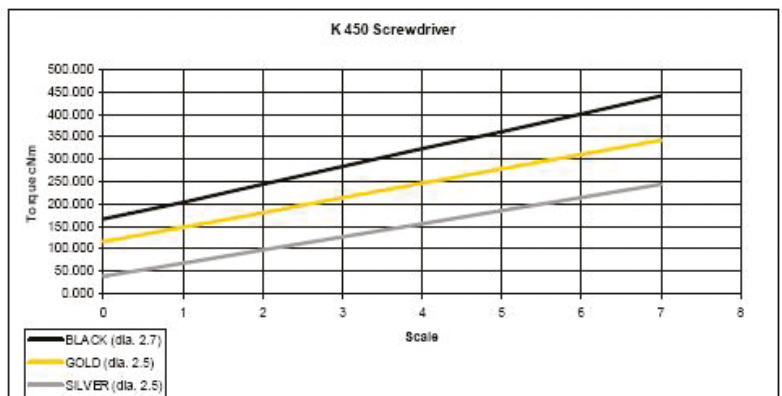
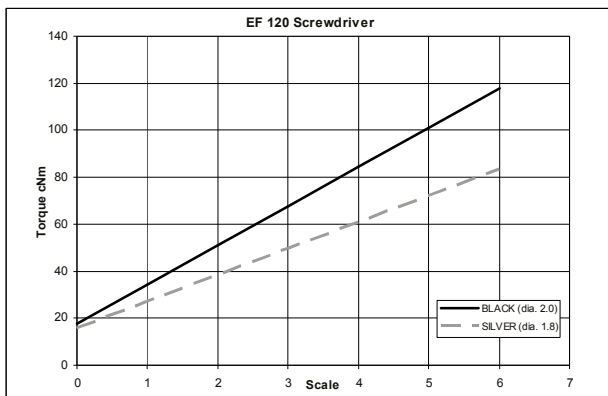

- ▶ These graphs should be used as a guide for setting the appropriate Electric Torque Screwdriver
- ▶ The Screwdriver has a torque scale on the Torque Adjustment Collar showing reference numbers. These numbers determine the approximate torque setting for the spring type (colour) being used

Order now... call our Sales Hotline +44 (0) 1483 894 476

Order Code	Model	Range		RPM		Drive	g		CE
		ISO	Imperial	Hi	Low				
090010	EF 120	5-115 cN.m	0.5-10 lbf-in	700	460		311	✓	✓
090150	K 450	30-440 cN.m	2.5-40 lbf-in	550	330		595	✓	✓
090000	STC 30+ Controller	-	-	-	-	-	950	-	✓

Ergo Quickset Adjustable Torque Screwdrivers

Torque range from 0.08 to 9 N.m

Compact **EPA compliant** ergonomic tools using Slipping Technology

Industry Sectors

Maintenance & Repair



Aerospace



Electronics



Military



Consumer Products

Can be supplied as part of a **Service Repair Kit...**
call our Sales Team to discuss
+44 (0) 1483 894 476

Slipping Mechanism

Incorrect tightening is impossible



T-Bar is not included with the Ergo Quickset Screwdriver Range



QSN 120 SD

QSN 120 FH

Key Benefits

- Quickset screwdrivers achieve accurate torque application by eliminating both under and over tightening using Torqueleader's proven slipping technology. This enables any user to deliver the correct torque with confidence regardless of task and operator skill level
- Fast and accurate to set, using the quick and clear to read micrometer style setting scale
- A single tool can cover a broad variety of applications due to its wide torque range
- Long service life is provided through the durable design utilising hard wearing materials such as stainless steel and aluminium
- Ideal for safe electronic component assembly as this tool is **EPA compliant** for use in Electrostatically Sensitive Areas
- Reduces operator fatigue due to a specially designed ergonomic hand grip combined with a smooth tool reset action



Calibrate your Ergo Screwdriver... visit www.torqueleader.com for more details about our on site UKAS (United Kingdom Accreditation Service) Calibration Laboratory

Models...

All models available with either ¼" Square Drive (SD) or ¼" Female Hex (FH) Drive

Want to know how to use this tool?



Watch our video



Optional Lock On T-Bar for larger models of screwdriver, provides extra leverage when required

(Order Code: **P29530**)

Order now... call our Sales Hotline +44 (0) 1483 894 476

Order Code	Model	← Calibrated Range →		Drive	k mm	g	Accuracy	ISO 6789 Class	Adjusting Lock Colour	
		Range	للسلسبا							
060700	QSN 40 FH	8-40 cN.m	1 cN.m		159	124	+/- 6%	2D	Blue	✓
060900	QSN 40 SD	8-40 cN.m	1 cN.m		159	124	+/- 6%	2D	Blue	✓
060740	QSA 60 FH	12-60 ozf.in	1 ozf.in		159	124	+/- 6%	2D	Gold	✓
060940	QSA 60 SD	12-60 ozf.in	1 ozf.in		159	124	+/- 6%	2D	Gold	✓
060720	QSA 4 FH	0.8-4 lbf.in	0.1 lbf.in		159	124	+/- 6%	2D	Red	✓
060920	QSA 4 SD	0.8-4 lbf.in	0.1 lbf.in		159	124	+/- 6%	2D	Red	✓
060100	QSN 120 FH	20-120 cN.m	1 cN.m		183	230	+/- 6%	2D	Blue	✓
060200	QSN 120 SD	20-120 cN.m	1 cN.m		183	230	+/- 6%	2D	Blue	✓
060140	QSA 160 FH	20-160 ozf.in	1 ozf.in		183	230	+/- 6%	2D	Blue	✓
060240	QSA 160 SD	20-160 ozf.in	1 ozf.in		183	230	+/- 6%	2D	Blue	✓
060120	QSA 12 FH	2-12 lbf.in	0.1 lbf.in		183	230	+/- 6%	2D	Grey	✓
060220	QSA 12 SD	2-12 lbf.in	0.1 lbf.in		183	230	+/- 6%	2D	Grey	✓
060300	QSN 600 FH	1-6 N.m	0.1 N.m		196	335	+/- 6%	2D	Red	✓
060400	QSN 600 SD	1-6 N.m	0.1 N.m		196	335	+/- 6%	2D	Red	✓
060320	QSA 50 FH	10-50 lbf.in	1 lbf.in		196	335	+/- 6%	2D	Red	✓
060420	QSA 50 SD	10-50 lbf.in	1 lbf.in		196	335	+/- 6%	2D	Red	✓
060500	QSN 900 FH	4-9 N.m	0.1 N.m		196	335	+/- 6%	2D	Green	✓
060600	QSN 900 SD	4-9 N.m	0.1 N.m		196	335	+/- 6%	2D	Green	✓
060520	QSA 80 FH	30-80 lbf.in	1 lbf.in		196	335	+/- 6%	2D	Green	✓
060620	QSA 80 SD	30-80 lbf.in	1 lbf.in		196	335	+/- 6%	2D	Green	✓

Quickset Adjustable Torque Screwdrivers

Torque range from 0.2 to 9 N.m

Calibrated scale tools using Slipping Technology to eliminate under and over tightening

Industry Sectors

Maintenance
& Repair



Aerospace



Electronics



Military



Consumer
Products

Like this tool, but need
to be **EPA Compliant...**
see pages 20-21 or visit
www.torqueleader.com

Slipping Mechanism

Incorrect tightening is impossible



T-Bar is not included with
the Quickset Screwdriver Range



Quickset 6 SD

Quickset 6 FH



Models also available in kgf.cm/kgf.m
See www.torqueleader.com

Key Benefits

- Quickset screwdrivers achieve accurate torque application by eliminating both under and over tightening using Torqueleader's proven slipping technology. This enables any user to deliver the correct torque with confidence regardless of task and operator skill level
- Fast and accurate to set, using the quick and clear to read micrometer style setting scale
- A single tool can cover a broad variety of applications due to its wide torque range
- Long service life is provided through the durable design utilising hard wearing materials such as stainless steel and aluminium
- Optional Lock On T-Bar for larger models of screwdriver, provides extra leverage when required (Order Code: **P29530**)



Calibrate your Quickset Screwdriver... visit www.torqueleader.com for more details about our on site UKAS (United Kingdom Accreditation Service) Calibration Laboratory

Models...

Quickset (ISO & Imperial Scales)

All models available with either 1/4" Square Drive (SD) or 1/4" Female Hex (FH) Drive

Want to know how to use this tool?



Watch our video



Details of Accessories... see pages 63-64 or visit www.torqueleader.com



Order Code	Model	← Calibrated Range →		Drive	k mm	g	Accuracy	ISO 6789 Class	Colour
		Range	سسسس						
016000	Quickset Minor Metric SD	20-120 cN.m	1 cN.m	1/4	160	158	+/- 6%	2D	Black
016040	Quickset Minor Metric FH	20-120 cN.m	1 cN.m	1/4	169	165	+/- 6%	2D	Black
016020	Quickset Minor Imp SD	20-120 ozf.in	1 ozf.in	1/4	160	158	+/- 6%	2D	Black
016060	Quickset Minor Imp FH	20-120 ozf.in	1 ozf.in	1/4	169	165	+/- 6%	2D	Black
016080	Quickset Minor lbf.in SD	2-12 lbf.in	0.1 lbf.in	1/4	160	158	+/- 6%	2D	Grey
016070	Quickset Minor lbf.in FH	2-12 lbf.in	0.1 lbf.in	1/4	169	165	+/- 6%	2D	Grey
016100	Quickset 6 SD	1-6 N.m	0.1 N.m	1/4	222	340	+/- 6%	2D	Red
016500	Quickset 6 FH	1-6 N.m	0.1 N.m	1/4	184	335	+/- 6%	2D	Red
016200	Quickset 50 SD	5-50 lbf.in	1 lbf.in	1/4	222	340	+/- 6%	2D	Red
016600	Quickset 50 FH	5-50 lbf.in	1 lbf.in	1/4	184	335	+/- 6%	2D	Red
016300	Quickset 9 SD	4-9 N.m	0.1 N.m	1/4	222	340	+/- 6%	2D	Green
016700	Quickset 9 FH	4-9 N.m	0.1 N.m	1/4	184	335	+/- 6%	2D	Green
016400	Quickset 80 SD	30-80 lbf.in	1 lbf.in	1/4	222	340	+/- 6%	2D	Green
016800	Quickset 80 FH	30-80 lbf.in	1 lbf.in	1/4	184	335	+/- 6%	2D	Green

Dual Scale Quickset Screwdrivers Available:

Order Code	Model	← Calibrated Range →			Drive	k mm	g	Accuracy	ISO 6789 Class	Colour	
		ISO	سسسس	Imperial							
016010	Quickset Minor DS	20-120 cN.m	1 cN.m	20-120 ozf.in	1 ozf.in	1/4	160	158	+/- 6%	2D	Black
016150	Quickset 6 DS	1-6 N.m	0.1 N.m	5-50 lbf.in	1 lbf.in	1/4	169	340	+/- 6%	2D	Red

TSN & TSP Preset Slipping Torque Wrenches

Torque range from 1 to 125 N.m

Tools which eliminate under and over tightening in Production

Industry Sectors

Manufacturing



Automotive



Aerospace



Military



Consumer Products

For Switch Operated Signal Torque versions (Sw)... see pages 28-29 or visit www.torqueleader.com

Slipping Mechanism

Incorrect tightening is impossible



TSN 55

TSP 10

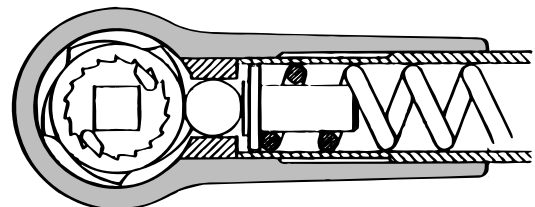

Working principle of the Torqueleader Slipping Wrenches

Key Benefits

- ▶ Accurate process control is ensured by eliminating under and over tightening due to the proven Torqueleader slipping technology regardless of operator's hand position
- ▶ Reduces the likelihood of warranty and rework by assuring process control through accurate and repeatable torque setting due to its tamper-proof adjusting system
- ▶ Process control can be further enhanced by using the Switch Operated Signal Torque versions (Sw) to confirm the correct torque has been applied to a particular fastener (see pages 28-29)
- ▶ Long tool service life is ensured by the robust design that is guaranteed by a two year warranty
- ▶ **EPA Compliant** for use in Electrostatically Sensitive Applications - see table for details



TSN & TSP Wrenches are preset type torque tools. They must be set to the required value by using a Torque Analyser like the **QTC**... see page 52 for details

Models...

TSP 5 & 10, TSN 25, 55 & 125

TSN 25 versions comes either with 1/4" or 3/8" Drive

Want to know how to use this tool?



Watch our video



Details of Sockets... see page 63 or visit www.torqueleader.com



Like this tool, but require a modification?
Call +44 (0) 1483 894 476 to discuss

Order now... call our Sales Hotline +44 (0) 1483 894 476

Order Code	Model	Range		Drive	k mm	kg	Repeatability	ISO 6789 Class	
		ISO	Imperial						
056090	TSP 5	1-5 N.m	10-45 lbf.in	1/4	185	0.19	+/- 6%	2C	✓
056100	TSP 10	2-10 N.m	20-90 lbf.in	1/4	185	0.19	+/- 6%	2C	✓
011017	TSN 25 D	5-25 N.m	4-18 lbf.ft	1/4	216	0.34	+/- 4%	2C	✓
011019	TSN 25 A	5-25 N.m	4-18 lbf.ft	3/8	216	0.34	+/- 4%	2C	✓
011035	TSN 55	15-55 N.m	10-40 lbf.ft	3/8	324	0.80	+/- 4%	2C	✗
011055	TSN 125	40-125 N.m	30-90 lbf.ft	1/2	460	1.36	+/- 4%	2C	✗

Slipping Wrenches with Through Hole Spindles

Torque range from 1 to 125 N.m

Designed for Pin Fastening Systems, which cannot be gripped in the conventional manner

Want to know how to use this tool?



Watch our video

Industry Sectors

Maintenance & Repair



Manufacturing



Slipping Mechanism

Incorrect tightening is impossible



TSP 10 Through Hole

Key Benefits

- Accurate tightening of blind fasteners such as HI-LITE®, AERO-LITE® and VERI-LITE® can be achieved with this innovative range of Through Hole Spindle Slipping Wrenches
- Accurate process control is ensured by eliminating under and over tightening due to the proven Torqueleader slipping technology, regardless of the operator's hand position
- Reduces the likelihood of warranty and rework by assuring process control through accurate and repeatable torque setting due to the tamper-proof adjusting system
- Long tool service life is ensured by the tool's robust design that is guaranteed by a two year warranty

Order now... call our Sales Hotline +44 (0) 1483 894 476

Order Code	Model	Range		Drive	Hole Diameter		kg	Repeatability	ISO 6789 Class
		ISO	Imperial		k mm	mm			
056092	TSP 5	1-5 N.m	10-45 lbf.in	1/4	3	185	0.19	+/- 6%	2C
056102	TSP 10	2-10 N.m	20-90 lbf.in	1/4	3	185	0.19	+/- 6%	2C
011019B17530	TSN 25 A	5-25 N.m	4-18 lbf.ft	3/8	4	216	0.34	+/- 4%	2C
011019B17531	TSN 25 A	5-25 N.m	4-18 lbf.ft	3/8	5	216	0.34	+/- 4%	2C
011019B22550	TSN 25 A	5-25 N.m	4-18 lbf.ft	3/8	6	216	0.34	+/- 4%	2C
011035B22490	TSN 55	15-55 N.m	10-40 lbf.ft	3/8	6	324	0.80	+/- 4%	2C
011055B22520	TSN 125	40-125 N.m	30-90 lbf.ft	1/2	8	460	1.36	+/- 4%	2C



Calibrate your Wrench using a Torque Analyser like the MTS or QTC... see pages 51-52 for details or contact us about our Calibration Service +44 (0) 1483 894 476

50V Insulated Preset Torque Wrenches

Torque range from 0.4 to 25 N.m

Tools which eliminate the risk of incorrect tightening where safety is important

Want to know how to use this tool?



Watch our video

Industry Sectors

Manufacturing



Utilities



Automotive

For appropriate Accessories...contact us on
+44 (0) 1483 894 476

Breaking Mechanism

Incorrect tightening is unlikely



TBN 10 50V



Key Benefits

- These wrenches are designed to minimise the possibility of incorrect tightening in low voltage applications up to 50V as these tools incorporate either Torqueleader's breaking or slipping mechanism
- The small and compact design combined with the totally insulated body is ideal for use in restricted space where there are electrically live components



Order now... call our Sales Hotline **+44 (0) 1483 894 476**

Order Code	Model	Range		Drive	k mm	kg	Repeatability
		ISO	Imperial				
011108	TBN 2 50V	0.4-2 N.m	3.5-18 lbf.in	1/4	105	0.17	+/- 6%
011208	TBN 10 50V	1-10 N.m	9-89 lbf.in	1/2	105	0.17	+/- 6%
011062	TSN 25 D 50V	5-25 N.m	4-18 lbf.ft	1/2	220	0.40	+/- 4%
011072	TSN 25 A 50V	5-25 N.m	4-18 lbf.ft	3/8	220	0.40	+/- 4%



These **Wrenches** are preset type torque tools. They must be set to the required value by using a Torque Analyser like the **QTC...** see **page 52** for details

Switch Operated Signal Torque Wrenches

Torque range from 0.4 to 200 N.m

Designed to provide fail safe tightening

Industry Sectors

Manufacturing



Automotive



Consumer Products

For End Fittings... see pages 60, 62-63
or visit www.torqueleader.com

Slipping Mechanism

Incorrect tightening is impossible



Breaking Mechanism

Incorrect tightening is unlikely



Key Benefits

- These wrenches give complete confidence that the tightening process has been performed by validating that the torque wrenches have operated. Upon each successful activation of the wrenches a signal is sent which can be used to control production flow or count completed tightenings
- Cost effective solution as these tools can be integrated into most Production Lines as the output signal is simply a switch opening and closing
- Suitable for use by operators of any skill level as the chance of under or over tightening is reduced or eliminated as these tools incorporate either the Torqueleader breaking or slipping mechanism
- A Signal Delay Unit (SDU) can be used to reduce the risk of missing wrench activations by extending the time of the signal output



Need one of our Technical Managers to visit you to demonstrate
Switch Operated Signal Torque Wrenches in more detail... call now on +44 (0) 1483 894 476

Models...

TSP, TSN & TBN ranges

Switch Operated Signal Torque Wrenches (Sw) are supplied complete with switch and cable

Want to know how to use this tool?



Watch our video



Signal Delay Unit (SDU)
Order Code: C12870



Universal Switch Module
Order Code: B25900

- Two types of cables are available - either a 5 metre, straight cable (Order Code: **D94402**) or a 1.5 metre coiled cable (Order Code: **D94406**)

- Universal Switch Module (as seen above Order Code: **B25900**) is connected via cable to the Production Line Control System

Order now... call our Sales Hotline +44 (0) 1483 894 476

Order Code	Model	Range		Drive	k mm* ↓	kg	Repeatability	ISO 6789 Class
		ISO	Imperial					
056093	TSP 5 Sw	1-5 N.m	10-45 lbf.in	$\frac{1}{4}$	335	0.53	+/- 6%	2C
056103	TSP 10 Sw	2-10 N.m	20-90 lbf.in	$\frac{1}{4}$	335	0.53	+/- 6%	2C
011003	TSN 25 D Sw	5-25 N.m	4-18 lbf.ft	$\frac{1}{4}$	366	0.68	+/- 4%	2C
011013	TSN 25 A Sw	5-25 N.m	4-18 lbf.ft	$\frac{3}{8}$	366	0.68	+/- 4%	2C
011033	TSN 55 Sw	15-55 N.m	10-40 lbf.ft	$\frac{3}{8}$	474	1.14	+/- 4%	2C
011053	TSN 125 Sw	40-125 N.m	30-90 lbf.ft	$\frac{1}{2}$	610	1.70	+/- 4%	2C
011103	TBN 2 Sw	0.4-2 N.m	3.5-18 lbf.in	Captive Pin	255	0.45	+/- 6%	2C
011113	TBN 2 G Sw	0.4-2 N.m	3.5-18 lbf.in	$\frac{9}{12}$	133	0.13	+/- 6%	2C
011203	TBN 10 Sw	1-10 N.m	9-89 lbf.in	Captive Pin	255	0.47	+/- 6%	2C
011213	TBN 10 G Sw	1-10 N.m	9-89 lbf.in	$\frac{9}{12}$	133	0.15	+/- 6%	2C
050003	TBN 25 Sw	5-25 N.m	4-18 lbf.ft	$\frac{1}{2}$	415	0.75	+/- 4%	2C
050013	TBN 25 G Sw	5-25 N.m	4-18 lbf.ft	$\frac{9}{12}$	415	0.75	+/- 4%	2C
050103	TBN 65 Sw	10-65 N.m	7-48 lbf.ft	$\frac{1}{2}$	452	1.09	+/- 4%	2C
050113	TBN 65 G Sw	10-65 N.m	7-48 lbf.ft	$\frac{9}{12}$	452	1.09	+/- 4%	2C
050203	TBN 135 Sw	27-135 N.m	18-100 lbf.ft	$\frac{1}{2}$	558	1.68	+/- 4%	2C
050213	TBN 135 G Sw	27-135 N.m	18-100 lbf.ft	$\frac{9}{12}$	558	1.68	+/- 4%	2C
050303	TBN 200 Sw	40-200 N.m	29-147 lbf.ft	$\frac{1}{2}$	670	1.74	+/- 4%	2C
050313	TBN 200 G Sw	40-200 N.m	29-147 lbf.ft	$\frac{14}{18}$	670	1.74	+/- 4%	2C

TBN Preset Breaking Torque Wrenches

Torque range from 0.4 to 200 N.m

Robust Production tools which reduce the chance of over tightening and are compatible with interchangeable end fittings

Industry Sectors

Maintenance & Repair



Military

Manufacturing



Military



Aerospace



Electronics



Automotive



Consumer Products

For details on the **TBN 2 & 10 SMA Connector Kit...**
see page 56
or call +44 (0) 1483 894 476

Breaking Mechanism

Incorrect tightening is unlikely



Key Benefits

- These wrenches improve control of the fastening process by reducing the risk of both under and over tightening. This is achieved by Torqueleader's unique breaking mechanism, which gives the operator more time to react once the target torque is reached
- Maximises productivity in restricted space applications through their compact slimline design
- Helps maintain production output by minimising operator fatigue through the ergonomic design
- Minimises tool replacement and downtime costs through a long lasting durable design proven by Torqueleader's rigorous lifecycle testing process
- Process control can be further enhanced by using the Switch Operated Signal Torque versions (Sw) to confirm the correct torque has been applied to a particular fastener (see pages 28-29)
- TBN 2 and 10 Wrenches will be supplied with a Calibration Certificate when ordered with an attached end fitting



TBN Wrenches are preset type torque tools. They must be set to the required value This is done by using a Torque Analyser like the **QTC...** see page 52 for more details

Models...

TBN 2, 10, 25, 65, 135 & 200

Rectangular fitting version also available

Want to know how to use this tool?



Watch our video



Details of End Fittings... see pages 60 & 62 or visit www.torqueleader.com



Order now... call our Sales Hotline +44 (0) 1483 894 476

Order Code	Model	Range		Drive	k mm	kg	Repeatability	ISO 6789 Class	
		ISO	Imperial						
011100	TBN 2	0.4-2 N.m	3.5-18 lbf.in	Captive Pin	105	0.11	+/- 6%	2C	✓
011110	TBN 2 G	0.4-2 N.m	3.5-18 lbf.in		133	0.13	+/- 6%	2C	✓
011200	TBN 10	1-10 N.m	9-89 lbf.in	Captive Pin	105	0.13	+/- 6%	2C	✓
011210	TBN 10 G	1-10 N.m	9-89 lbf.in		133	0.15	+/- 6%	2C	✓
050000	TBN 25	5-25 N.m	4-18 lbf.ft		265	0.41	+/- 4%	2C	✗
050010	TBN 25 G	5-25 N.m	4-18 lbf.ft		265	0.41	+/- 4%	2C	✗
050100	TBN 65	10-65 N.m	7-48 lbf.ft		302	0.75	+/- 4%	2C	✗
050110	TBN 65 G	10-65 N.m	7-48 lbf.ft		302	0.75	+/- 4%	2C	✗
050200	TBN 135	27-135 N.m	18-100 lbf.ft		408	1.03	+/- 4%	2C	✗
050210	TBN 135 G	27-135 N.m	18-100 lbf.ft		408	1.03	+/- 4%	2C	✗
050300	TBN 200	40-200 N.m	29-147 lbf.ft		520	1.40	+/- 4%	2C	✗
050310	TBN 200 G	40-200 N.m	29-147 lbf.ft		520	1.40	+/- 4%	2C	✗

TCP Production Clicker Torque Wrenches

Torque range from 2 to 200 N.m

Production tools which can be used with a range of interchangeable end fittings

Want to know how to use this tool?



Watch our video

Industry Sectors

Maintenance & Repair



Automotive



Aerospace



Utilities



Consumer Products

For TCP End Fittings... see page 62 or visit www.torqueleader.com

Clicking Mechanism

Incorrect tightening is possible



TCP 85 S

Key Benefits

- These preset wrenches ensure good tightening process control as unauthorised adjustment is prevented by its tamper-proof design
- Long service life is ensured by the robust design which utilises the highest quality materials. All are backed by a two year warranty
- The versatile design allows the use of a range of end fittings and ratchets for multiple industrial applications

Order now... call our Sales Hotline +44 (0) 1483 894 476

Order Code	Model	Range		Drive	k mm	kg	Repeatability	ISO 6789 Class
		ISO	Imperial					
024420	TCP 25 S	2-25 N.m	2-19 lbf.ft	16	180	0.21	+/- 4%	2C
024430	TCP 25 G	2-25 N.m	2-19 lbf.ft	9x12	180	0.21	+/- 4%	2C
024440	TCP 50 S	5-50 N.m	5-37.5 lbf.ft	16	240	0.27	+/- 4%	2C
024450	TCP 50 G	5-50 N.m	5-37.5 lbf.ft	9x12	240	0.27	+/- 4%	2C
024460	TCP 85 S	15-85 N.m	10-75 lbf.ft	16	320	0.34	+/- 4%	2C
024470	TCP 85 G	15-85 N.m	10-75 lbf.ft	9x12	320	0.34	+/- 4%	2C
024480	TCP 200 S	20-200 N.m	20-150 lbf.ft	16	400	0.75	+/- 4%	2C
024490	TCP 200 G	20-200 N.m	20-150 lbf.ft	14x18	400	0.75	+/- 4%	2C



These **Wrenches** are preset type torque tools. They must be set to the required value by using a Torque Analyser like the **QTC...** see page 52 for details

TSC Adjustable Slipping Torque Wrenches

Torque range from 1 to 10 N.m

Compact and lightweight tools which eliminate over tightening in a wide range of applications

Want to know how to use this tool?



Watch our video

Industry Sectors

Maintenance & Repair

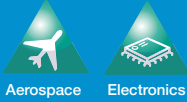

Manufacturing



For Sockets... see page 63 or visit www.torqueleader.com

Slipping Mechanism

Incorrect tightening is impossible



TSC 10



Models also available in kgf.cm/kgf.m See www.torqueleader.com



Key Benefits

- These wrenches improve control of the fastening process by eliminating the risk of incorrect tightening. This is achieved by Torqueleader's unique slipping mechanism
- Helps maintain production output by minimising operator fatigue through the tool's ergonomic design
- Maximises productivity in restricted space through its compact slimline design
- Minimises tool replacement and downtime costs, through a long lasting durable design proven by Torqueleader's rigorous lifecycle testing process
- EPA Compliant** for use in Electrostatically Sensitive Applications

Order now... call our Sales Hotline +44 (0) 1483 894 476

Order Code	Model	← Calibrated Range →		Drive	↕ mm ↕		Accuracy	ISO 6789 Class	
		Range	السلسلا		↕ g ↕				
056020	TSC 5	1-5 N.m	0.05 N.m	1/4	195	235	+/- 6%	2A	✓
056040	TSC 10	2-10 N.m	0.1 N.m	1/2	195	235	+/- 6%	2A	✓
056060	TSC 45	10-45 lbf.in	0.5 lbf.in	3/8	195	235	+/- 6%	2A	✓
056080	TSC 90	20-90 lbf.in	1.0 lbf.in	1/2	195	235	+/- 6%	2A	✓



Calibrate your TSC Wrench... visit www.torqueleader.com for more details about our on site UKAS (United Kingdom Accreditation Service) Calibration Laboratory

ATB Adjustable Breaking Torque Wrenches

Torque range from 0.5 to 10 N.m

Calibrated scale tools engineered to reduce the risk of under and over tightening in Production, Service and Repair

Industry Sectors

Maintenance & Repair



Automotive



Aerospace



Military

Manufacturing



Automotive

Can be supplied as part of a **Customised Kit...**
call our Sales Team to discuss
+44 (0) 1483 894 476

Breaking Mechanism

Incorrect tightening is unlikely



ATB 5

ATB 10 G

Key Benefits

- Compact design allows easy access where space is restricted
- Offers improved control of the tightening process by reducing the risk of under and over tightening. This is achieved by Torqueleader's unique breaking mechanism that allows the operator more time to react once the target torque is achieved
- **EPA Compliant** for use in Electrostatically Sensitive Applications - see table for details
- Versatile tools ideal for Maintenance & Repair applications where a range of torques can be applied quickly and easily to a variety of fasteners and connectors
- Reduces the likelihood of warranty and rework by assuring process control through accurate and repeatable torque application
- Fast and accurate to set using the quick and clear to read micrometer style setting scale



Calibrate your ATB Wrench... visit www.torqueleader.com for more details about our on site UKAS (United Kingdom Accreditation Service) Calibration Laboratory

Models...

ATB 2.5, 5 & 10

N.m or lbf.in versions come with either an 8 mm spigot or a rectangular fitting

Want to know how to use this tool?



Watch our video

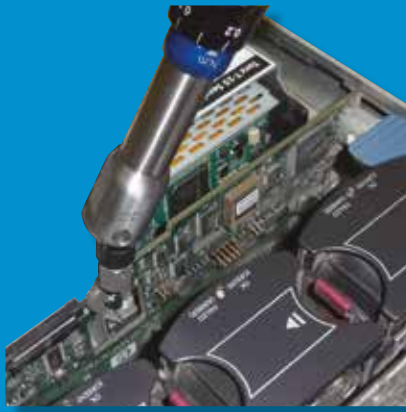

Details of Accessories... see pages 61 & 63 or visit www.torqueleader.com



Tool Selector

Visit www.torqueleader.com/tool-selector to check this is the right tool for your application?

Order Code	Model	← Calibrated Range →				Drive	k mm	kg	Accuracy	ISO 6789 Class	
		ISO	متر	Imperial	متر						
050520	ATB 2.5	50-250 cN.m	1.25 cN.m	-	-	⊗	190	0.24	+/- 6%	2A	✓
050525	ATB 2.5	-	-	4.5-22.5 lbf.in	0.1 lbf.in	⊗	190	0.24	+/- 6%	2A	✓
050527	ATB 2.5 G	50-250 cN.m	1.25 cN.m	-	-	⊗ ₁₂	192	0.27	+/- 6%	2A	✓
050532	ATB 2.5 G	-	-	4.5-22.5 lbf.in	0.1 lbf.in	⊗ ₁₂	192	0.27	+/- 6%	2A	✓
050500	ATB 5	1-5 N.m	0.025 N.m	-	-	⊗	220	0.29	+/- 6%	2A	✓
050505	ATB 5	-	-	10-45 lbf.in	0.25 lbf.in	⊗	220	0.29	+/- 6%	2A	✓
050507	ATB 5 G	1-5 N.m	0.025 N.m	-	-	⊗ ₁₂	230	0.29	+/- 6%	2A	✓
050512	ATB 5 G	-	-	10-45 lbf.in	0.25 lbf.in	⊗ ₁₂	230	0.29	+/- 6%	2A	✓
050550	ATB 10	2-10 N.m	0.05 N.m	-	-	⊗	220	0.30	+/- 6%	2A	✓
050555	ATB 10	-	-	20-90 lbf.in	0.5 lbf.in	⊗	220	0.30	+/- 6%	2A	✓
050557	ATB 10 G	2-10 N.m	0.05 N.m	-	-	⊗ ₁₂	230	0.30	+/- 6%	2A	✓
050562	ATB 10 G	-	-	20-90 lbf.in	0.5 lbf.in	⊗ ₁₂	230	0.30	+/- 6%	2A	✓

ATB Adjustable Breaking Torque Wrenches

Torque range from 5 to 100 N.m

Calibrated scale tools engineered to reduce the risk of under and over tightening in Production, Service and Repair

Industry Sectors

Maintenance & Repair



Automotive



Aerospace



Military

Manufacturing



Automotive

Private label this tool...
call +44 (0) 1483 894 476

Breaking Mechanism

Incorrect tightening is unlikely



ATB 100

ATB 25 showing N.m Scale

Key Benefits

- Offers improved control of the tightening process by reducing the risk of under and over tightening. This is achieved by Torqueleader's unique breaking mechanism that allows the operator more time to react once the target torque is achieved
- Fast and accurate to set using the quick and clear to read micrometer style setting scale
- Versatile tools ideal for Maintenance & Repair applications where a range of torques can be applied quickly and easily to a range of fasteners
- Reduces the likelihood of warranty and rework by assuring process control through accurate and repeatable torque application



Calibrate your ATB Wrench... visit www.torqueleader.com for more details about our on site UKAS (United Kingdom Accreditation Service) Calibration Laboratory

Models...

ATB 25, 50 & 100

1/4", 3/8", 1/2" interchangeable ratchet heads come as standard available in N.m, lbf.in or lbf.ft versions

Want to know how to use this tool?



Watch our video

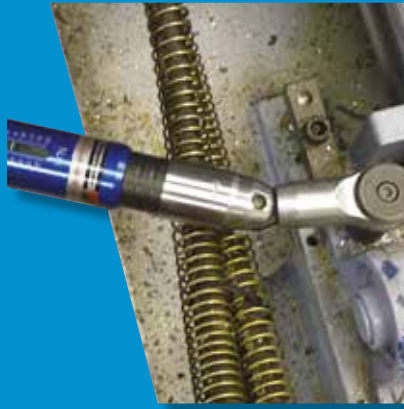

For Wrench End Fittings & Sockets... see pages 62 - 63



Tool Selector

Visit www.torqueleader.com/tool-selector to check this is the right tool for your application?

Order now... call our Sales Hotline +44 (0) 1483 894 476

Order Code	Model	ISO	Calibrated Range			Drive	k mm	kg	Accuracy	ISO 6789 Class
			ISO	Imperial	Imperial					
050636	ATB 25 D	5-25 N.m	0.1 N.m	-	-	1/4"	345	1.11	+/- 4%	2A
050641	ATB 25 D	-	-	50-250 lbf.in	1 lbf.in	1/4"	345	1.11	+/- 4%	2A
050646	ATB 25 D	-	-	4-20 lbf.ft	0.1 lbf.ft	1/4"	345	1.11	+/- 4%	2A
050638	ATB 25 A	5-25 N.m	0.1 N.m	-	-	3/8"	345	1.12	+/- 4%	2A
050643	ATB 25 A	-	-	50-250 lbf.in	1 lbf.in	3/8"	345	1.12	+/- 4%	2A
050648	ATB 25 A	-	-	4-20 lbf.ft	0.1 lbf.ft	3/8"	345	1.12	+/- 4%	2A
050685	ATB 50	10-50 N.m	0.25 N.m	-	-	3/8"	365	1.14	+/- 4%	2A
050690	ATB 50	-	-	120-440 lbf.in	2 lbf.in	3/8"	365	1.14	+/- 4%	2A
050695	ATB 50	-	-	7-37 lbf.ft	0.125 lbf.ft	3/8"	365	1.14	+/- 4%	2A
050735	ATB 100	20-100 N.m	0.5 N.m	-	-	1/2"	400	1.30	+/- 4%	2A
050740	ATB 100	-	-	240-880 lbf.in	4 lbf.in	1/2"	400	1.30	+/- 4%	2A
050745	ATB 100	-	-	14-74 lbf.ft	0.25 lbf.ft	1/2"	400	1.30	+/- 4%	2A

TCR Adjustable Clicker Torque Wrenches

Torque range from 1 to 750 N.m

Adjustable general tools for Service and Repair

Want to know how to use this tool?



Watch our video

Industry Sectors

Maintenance & Repair



Automotive



Aerospace



Utilities



Consumer Products

For Sockets... see page 63 or visit www.torqueleader.com

Clicking Mechanism

Incorrect tightening is possible



TCR 100



Interchangeable 1/4" and 3/8" Square Drive



Push Through 1/2" Square Drive

Order Code	Drive
024000	1/4"
024010	3/8"
024020	1/2"

Key Benefits

- Cost effective wrenches which are ideal for covering a wide number of tasks as the operator can adjust them to deliver a broad range of torques
- Minimises the time to complete the task as these wrenches are quick and easy to adjust due to the clear scale design and simple to use locking mechanism
- Long service life is ensured by the robust design which utilises the highest quality materials. All are backed by a two year warranty

Order now... call our Sales Hotline +44 (0) 1483 894 476

Order Code	Model	← Calibrated Range →			Drive	k	mm	kg	Accuracy	ISO 6789 Class
		ISO	المقياس	Imperial						
024060	TCR 5 D	1-5 N.m	0.025 N.m	0.75-3.7 lbf.ft	1/4"	224	0.32	+/- 6%	2A	
024080	TCR 25 D Slim	2-25 N.m	0.1 N.m	2-19 lbf.ft	1/4"	285	0.45	+/- 4%	2A	
024090	TCR 220 D	-	-	20-220 lbf.in	1/4" + 3/8"	284	0.45	+/- 4%	2A	
024125	TCR 50 Slim	5-50 N.m	0.25 N.m	5-37.5 lbf.ft	3/8"	335	0.54	+/- 4%	2A	
024140	TCR 100	10-100 N.m	0.5 N.m	10 -75 lbf.ft	1/2"	394	0.90	+/- 4%	2A	
024160	TCR 200	20-200 N.m	1 N.m	20-150 lbf.ft	1/2"	485	1.10	+/- 4%	2A	
024180	TCR 300	60-300 N.m	1 N.m	50-220 lbf.ft	1/2"	577	1.40	+/- 4%	2A	
024200	TCR 400	75-400 N.m	1 N.m	60-300 lbf.ft	3/4"	686	2.00	+/- 4%	2A	
024220	TCR 550	100-550 N.m	1 N.m	75-400 lbf.ft	3/4"	957	3.80	+/- 4%	2A	
024240	TCR 750	140-750 N.m	1 N.m	100-550 lbf.ft	3/4"	1236	4.80	+/- 4%	2A	



Is correct tightening critical for your application... watch our **Slip, Break and Click Mechanism** video at www.youtube.com/torqueleader to ensure the right tool choice

TCS & TCG Adjustable Clicker Torque Wrenches

Torque range from 2 to 400 N.m

Adjustable general tools for Service and Repair

Want to know how to use this tool?



Watch our video

Industry Sectors

Maintenance & Repair



Automotive



Aerospace



Utilities



Consumer Products

For TCS End Fittings... see page 62 or visit www.torqueleader.com

Clicking Mechanism

Incorrect tightening is possible



TCS 100

Key Benefits

- Cost effective wrenches which are ideal for covering a wide number of tasks as the operator can adjust them to deliver a broad range of torques
- Minimises the time to complete the task as these wrenches are quick and easy to adjust due to the clear scale design and simple to use locking mechanism
- Long service life is ensured by the robust design which utilises the highest quality materials. All are backed by a two year warranty
- The versatile design allows the use of a range of end fittings and ratchets for multiple industrial applications

Order now... call our Sales Hotline +44 (0) 1483 894 476

Order Code	Model	← Calibrated Range →			Drive	k mm	kg	Accuracy	ISO 6789 Class
		ISO	للسلسل	Imperial					
024305	TCS 25 Slim	2-25 N.m	0.10 N.m	2-19 lbf.ft	16	280	0.50	+/- 4%	2A
024325	TCS 50 Slim	5-50 N.m	0.25 N.m	5-37.5 lbf.ft	16	330	0.60	+/- 4%	2A
024340	TCS 100	10-100 N.m	0.50 N.m	10-75 lbf.ft	16	375	0.60	+/- 4%	2A
024360	TCS 200	20-200 N.m	1 N.m	20-150 lbf.ft	16	465	0.80	+/- 4%	2A
024380	TCS 300	60-300 N.m	1 N.m	50-220 lbf.ft	16	565	1.20	+/- 4%	2A
024400	TCS 400	75-400 N.m	1 N.m	60-300 lbf.ft	16	650	1.50	+/- 4%	2A
024510	TCG 25 Slim	2-25 N.m	0.10 N.m	2-19 lbf.ft	9x12	280	0.50	+/- 4%	2A
024520	TCG 50 Slim	5-50 N.m	0.25 N.m	5-37.5 lbf.ft	9x12	330	0.60	+/- 4%	2A
024530	TCG 100	10-100 N.m	0.50 N.m	10-75 lbf.ft	9x12	375	0.60	+/- 4%	2A
024540	TCG 200	20-200 N.m	1 N.m	20-150 lbf.ft	14x18	465	0.80	+/- 4%	2A
024550	TCG 300	60-300 N.m	1 N.m	50-220 lbf.ft	14x18	565	1.20	+/- 4%	2A
024560	TCG 400	75-400 N.m	1 N.m	60-300 lbf.ft	14x18	650	1.50	+/- 4%	2A

Tool Selector

Is this the right tool for your Torque application... why not check out our Tool Selector at www.torqueleader.com/tool-selector

Weld Stud Test Tools

Torque range from 0.4 to 20 N.m

Quick to use Go/No Go testers for weld stud integrity

Industry Sectors

Quality Control



Automotive



Aerospace



Electronics



Consumer Products

For more information on these tools...
visit www.torqueleader.com
or call +44 (0) 1483 894 476

Breaking Mechanism

Incorrect tightening is unlikely



Key Benefits

- Go/No Go tests for weld stud integrity can be carried out quickly and efficiently using the WSTT product range
- Easy and effective to use due to its intuitive T-Bar design and Torqueleader's breaking technology
- Versatile Quality Audit tools which cover a range of weld studs from M2.5 to M12
- Long service life guaranteed by a robust design backed up by a two year warranty
- WSTT Tools will be supplied with a Calibration Certificate when ordered with an attached end fitting



Need one of our Technical Managers to visit you to demonstrate our **Weld Stud Test Tools** in more detail... call now on +44 (0) 1483 894 476

Models...

WSTT 2, 10 & 20

A range of end fittings are available for use with most popular weld stud thread sizes and lengths

Want to know how to use this tool?



Watch our video



Weld Stud Test Tool Setting Adaptor
Order Code: A25880



Typical Maximum Torque Test Values (Capacitor discharge method)

Threaded Stud	Steel 4.8 Weldable	Stainless Steel 1.403/03 (A2-50)	Aluminium Alloy AlMg3 F23	Copper CuZn37 (Ms63)
M3	1.2 N.m	0.75 N.m	0.6 N.m	0.9 N.m
M4	2.7 N.m	1.4 N.m	1.3 N.m	1.9 N.m
M5	5.4 N.m	3.5 N.m	2.9 N.m	4.0 N.m
M6	9.2 N.m	5.7 N.m	4.6 N.m	6.75 N.m
M8	12.0 N.m	14.0 N.m	11.25 N.m	16.5 N.m
M10	18.0 N.m	20.0 N.m	-	-

NOTE: These torque values are for guidance only. The torque for each application should be calculated and proven by practical test.

Order now... call our Sales Hotline +44 (0) 1483 894 476

Order Code	Model	Calibrated Range		k mm	g
		ISO	Imperial		
055005	WSTT 2	0.4-2 N.m	3.5-18 lbf.in	120	215
055000	WSTT 10	1-10 N.m	9-90 lbf.in	120	215
055010	WSTT 20	4-20 N.m	35-180 lbf.in	220	320

Metric or Imperial range of End Fittings available...

Metric			
Order Code WSTT 10	Weld Stud Thread x Maximum Length	Order Code WSTT 20	Weld Stud Thread x Maximum Length
055020	M2.5 x 25	055050	M5 x 50
055025	M3 x 50	055055	M6 x 50
055030	M4 x 50	055060	M8 x 50
055035	M5 x 50	055065	M10 x 75
055040	M6 x 50	055070	M12 x 75
055045	M8 x 50	-	-

Imperial			
Order Code WSTT 10	Weld Stud Thread x Maximum Length	Order Code WSTT 20	Weld Stud Thread x Maximum Length
055075	4-40 x 1.5"	055105	10-32 x 2.5"
055080	6-32 x 2"	055110	10-24 x 2.5"
055085	8-32 x 2"	055115	1/4-20 x 4"
055090	10-32 x 2.5"	055120	5/16-18 x 4"
055095	10-24 x 2.5"	055125	3/8-16 x 4"
055100	1/4-20 x 4"	-	-

RTU Dynamic Torque Limiters

Torque range from 0.2 to 10 N.m

Designed to eliminate over tightening

Want to know how to use this tool?



Watch our video

Industry Sectors

Maintenance & Repair



Utilities

Manufacturing



Packaging

Customised RTU can be supplied... see page 57 or visit www.torqueleader.com

Slipping Mechanism

Incorrect tightening is impossible



RTU 1000 HEX



RTU 1000



Key Benefits

- Versatile torque limiters that allow conventional Hand and Power tools to be easily converted into Torque Tools
- Accurate process control assured by eliminating under and over tightening due to the proven Torqueleader slipping technology
- Hand tools can be converted into Torque Tools using a range of heavy duty torque limiters – custom designs available
- A wide range of potential applications can be catered for by the flexible design options offered

Order now... call our Sales Hotline +44 (0) 1483 894 476

Order Code	Model	Range		Speed	Input Drive	Output Drive	Repeatability	ISO 6789 Class
		N.m	lbf.in					
018100	RTU 170	20-170 cN.m	1.8-15 lbf.in	0-500	$\frac{3}{8}$	$\frac{3}{8}$	+/- 6%	2F
018120	RTU 170 HEX	20-170 cN.m	1.8-15 lbf.in	0-500	$\frac{1}{2}$	$\frac{1}{2}$	+/- 6%	2F
018200	RTU 450	1-4.5 N.m	9-40 lbf.in	0-500	$\frac{3}{8}$	$\frac{3}{8}$	+/- 6%	2F
018220	RTU 450 HEX	1-4.5 N.m	9-40 lbf.in	0-500	$\frac{1}{2}$	$\frac{1}{2}$	+/- 6%	2F
018300	RTU 1000	4-10 N.m	36-88 lbf.in	0-250	$\frac{3}{8}$	$\frac{3}{8}$	+/- 6%	2F
018320	RTU 1000 HEX	4-10 N.m	36-88 lbf.in	0-250	$\frac{1}{2}$	$\frac{1}{2}$	+/- 6%	2F



If required RTU Torque Limiters are available at higher torque settings... why not discuss your needs with us by calling now on +44 (0) 1483 894 476

Introduction to Torque Calibration

- Guarantees repeated Torque Tool accuracy and adherence to International Standards
- Ensures torque equipment is operating to peak performance diagnosing problems before they arise



In this section...

- Explanation of the importance of Torque Calibration
- Mechanical Analysers for low range Hand Torque Tools
- Digital Torque Analysers offering a variety of features

Types of Calibration Analysers

Electronic Analysers... are highly accurate, reliable and easy to use. Our modern range of Digital Torque Calibration Equipment can allow the user to download test results, test power tools, select different units of measurement and carry out calibration beyond the scope of mechanical calibration devices.

Mechanical Analysers... are low cost, robust and easy to use devices that are designed to set and calibrate low range Hand Torque Tools. These Analysers will give many years of accurate and reliable service.

Functions of Analysers

Torque Calibration Analysers	Screwdriver Testing	Wrench Testing	Powered Tool Testing	Memory Capability	PC Download Capability	Interchangeable Sensors
CAPTURE System	✓	✓	✓	✓	✓	✓
ET-cal II Compact	✓	✓	✓	✓	✓	-
MTP	✓	-	-	-	-	-
MTS	✓	✓	-	-	-	-
QTC	✓	✓	-	-	✓	-



“ Call **+44 (0) 1483 894 476** to discuss how to calibrate your Torque Tool or use our In House Calibration Service ”

For more information on...

- **Selecting the right tool** - Go to www.torqueleader.com/tool-selector
- **Using our tools** - Visit www.youtube.com/torqueleader
- **Price and availability** - Call our Sales Hotline **+44 (0) 1483 894 476**

CAPTURE System

A New Standard in Torque Analyser Systems

Want to know how to use this tool?



Watch our video



CAPTURE System



*TSN is not part of the CAPTURE System

Key Benefits

- Highly accurate measurement of Hand and Power Torque Tools, the System has been designed and tested in conjunction with the National Physical Laboratory in the UK, a world leader in electronic measurement systems
- Designed to allow users to become productive quickly as the System is quick to set up and requires little training due to the System's intuitive easy to use menus and Plug & Play connectivity
- The CAPTURE System maximises Torque Tool test efficiency as the Display, Sensor and Manager PC software have been designed to work together, automating many functions
- Versatile design allows static laboratory use and mobile data collection using an onboard memory and rechargeable battery. The data can then be transferred to PC via USB connection

Want to know more...
Watch our CAPTURE Virtual Tour
www.torqueleader.com



For more information on the individual CAPTURE components...
visit www.torqueleader.com

CAPTURE Display

Intuitive easy to use Display

Want to know how to use this tool?



Watch our video



CAPTURE Display



Key Benefits

- Designed to allow users to become productive quickly due to its intuitive features, such as easy to navigate menus, tool database and Plug & Play integration with CAPTURE Sensors
- Versatile design allows static laboratory use and mobile data collection using an onboard memory and rechargeable battery. The data can then be transferred to PC via USB connection
- Minimise investment, as the CAPTURE Display is designed to integrate with customers' existing industry standard nominal 2mV/V Sensors
- To protect the CAPTURE Display when not in use it is supplied complete in a high impact plastic carry case. In addition the following items are included with the Display and are stored in the case - USB Power Cable (for charging from Mains or PC and also used for data transfer), Power Supply (multi-national), Calibration Certificate, Start Up Guide and Instructions
- CAPTURE Display can store 500 tools and 2000 data readings in the onboard memory
- Work for longer between battery charges as the unit is fitted with a long life Lithium-ion battery and has an auto power down mode

Order now... call our Sales Hotline +44 (0) 1483 894 476

Order Code	Model
036700	CAPTURE Display

Order Code	Model
036226	CAPTURE Cable - CAPTURE Display to Custom Sensor
036246	CAPTURE Cable - CAPTURE Display to Capture Sensor
036251	CAPTURE Cable - CAPTURE Display to SDX Screwdriver
036256	CAPTURE Cable - CAPTURE Display to ETX Wrench



Want to know how this product works...
visit **CAPTURE Virtual Tour** at www.torqueleader.com

CAPTURE

Sensor

Torque Range from 0.2 to 1500 N.m

Want to know how to use this tool?



Watch our video



CAPTURE Sensor

Order Code	Model
036771	CAPTURE Sensor ISO 1500/90° Adaptor
D18205	CAPTURE Sensor ISO-A Mount
036772	CAPTURE Sensor Quick Change Plate

Key Benefits

- Built-in flexibility as the sensor can be mounted horizontally or vertically without the need for any accessories
- Fast to set up when used with a CAPTURE Display due to the imbedded Quicktec technology which passes all the Sensor information to the Display
- Remove human error from testing by using the CAPTURE Sensor with the ISO 1500/90° Torque Loading System (Adaptor required – see **page 53**)
- To protect the Sensor when not in use it is supplied in a high impact plastic carry case
- Easy to repair due to modular design that allows for simple component replacement
- For users with limited space who need to change Sensors between tests the Quick Change Plate increases calibration productivity
- Sensors come complete with UKAS certificate to BS 7882:2008 Class 1 or better
- Calibrated range is 10% to 100% of capacity

Order now... call our Sales Hotline +44 (0) 1483 894 476

Order Code	Model	Range	Drive	mm H x W x D	kg	Hole Centres (mm)	Mounting Hole Size	Fixings Supplied	Order Code
036805	CS 2	0.2-2 N.m	$\frac{1}{4}$	62 x 85 x 65	0.50	56	M8 x 1.25 (10 Deep Min)	M8 x 50 *	P34320
036807	CS 5	0.5-5 N.m	$\frac{1}{4}$	62 x 85 x 65	0.50	56	M8 x 1.25 (10 Deep Min)	M8 x 50 *	P34320
036810	CS 10	1-10 N.m	$\frac{1}{4}$	62 x 85 x 65	0.50	56	M8 x 1.25 (10 Deep Min)	M8 x 50 *	P34320
036815	CS 25	2.5-25 N.m	$\frac{3}{8}$	62 x 85 x 65	0.50	56	M8 x 1.25 (10 Deep Min)	M8 x 50 *	P34320
036820	CS 50	5-50 N.m	$\frac{3}{8}$	62 x 85 x 65	0.57	56	M8 x 1.25 (10 Deep Min)	M8 x 50 *	P34320
036825	CS 100	10-100 N.m	$\frac{1}{2}$	62 x 85 x 65	0.60	56	M8 x 1.25 (10 Deep Min)	M8 x 50 *	P34320
036830	CS 250	25-250 N.m	$\frac{1}{2}$	82 x 120 x 87	1.45	79	M12 x 1.75 (16 Deep Min)	M12 x 1.75 *	P34330
036835	CS 500	50-500 N.m	$\frac{3}{4}$	82 x 120 x 87	1.6	79	M12 x 1.75 (16 Deep Min)	M12 x 1.75 *	P34330
036845	CS 1500	150-1500 N.m	T	100 x 165 x 134	4.00	125	M16 x 2.0 (20 Deep Min)	M16 x 90 *	P34340

* Socket Cap Head Screw



Calibrate your Sensor... visit www.torqueleader.com for more details about our on site UKAS (United Kingdom Accreditation Service) Calibration Laboratory

CAPTURE Manager

PC Software - effectively manage your data

Want to know how to use this tool?



Watch our video



CAPTURE Manager

Key Benefits

- Manage tool and test data through the CAPTURE Manager PC software. The software also makes analysing the data quick and easy through integration with Microsoft Excel®
- The CAPTURE Manager PC software allows unlimited storage of tools and data readings which can be uploaded and downloaded to the CAPTURE Display via USB connection
- Ensures tools are performing to the required standard through the ISO 6789:2003 test wizard. This clear and easy to use feature guides the user through the test procedure
- Tool traceability can be achieved as the CAPTURE Manager PC software can generate customised calibration certificates to the requirements of ISO 6789:2003

Order now... call our Sales Hotline +44 (0) 1483 894 476

Order Code	
036710	CAPTURE Manager - PC Software



To learn more about the CAPTURE System watch our videos on



www.youtube.com/torqueleader



Need one of our Technical Managers to visit you to demonstrate the CAPTURE System in more detail... call now on +44 (0) 1483 894 476

Rotary Torque Sensors

Torque range from 0.2 to 1400 N.m

Accurate Sensors used in conjunction with our CAPTURE Display

Want to know how to use this tool?



Watch our video

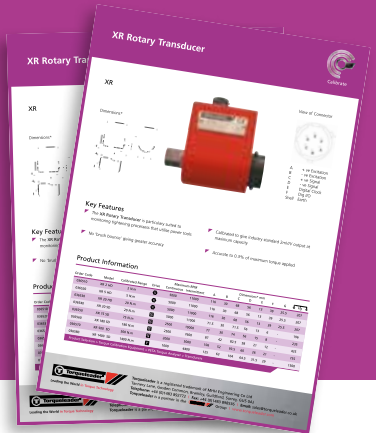
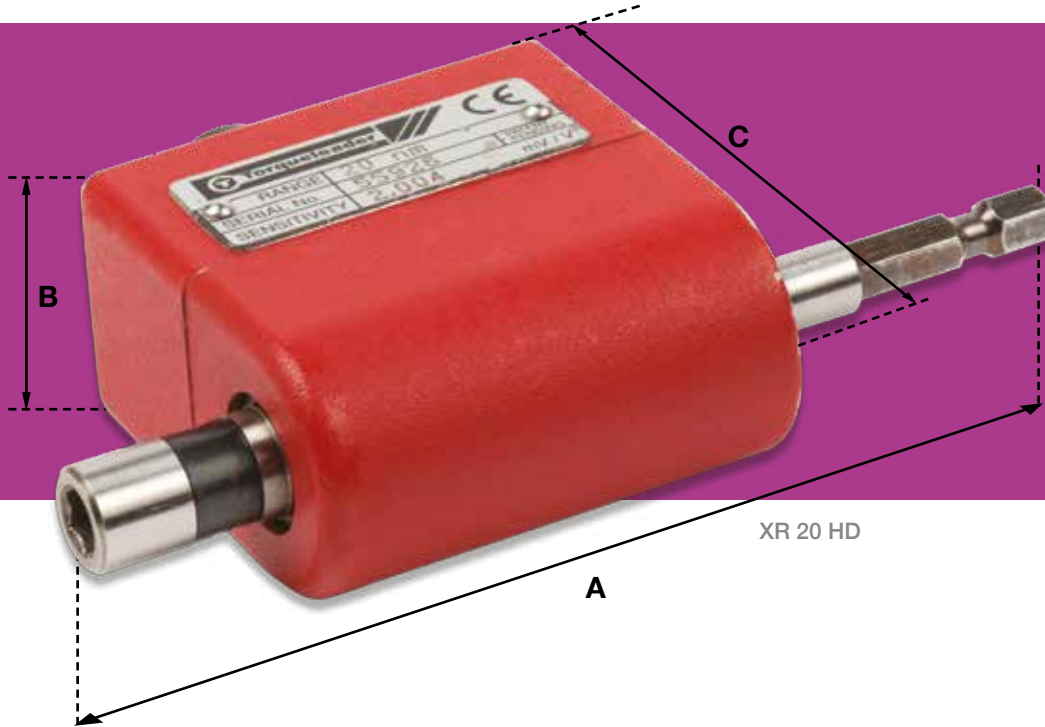

To download detailed Product Card go to

www.torqueleader.com

Key Benefits

- These Sensors are designed to ensure your tightening process is within acceptable limits with a high degree of certainty. Designed to be placed inline with the tooling they measure the actual torque into the application accurate to 0.3% of maximum torque applied
- Rotary Sensors come complete with UKAS certificates
- The unique design ensures measurement accuracy is maintained even in high vibration applications by eliminating brush bounce which can compromise the accuracy
- A cost effective solution, as in most cases, there is no need to upgrade your current Torque Analyser. These Sensors are designed to be compatible with most industry standard devices

Order now... call our Sales Hotline +44 (0) 1483 894 476

Order Code	Model	Calibrated Range		Maximum RPM		A	B	C	kg
		ISO	Drive	Continuous	Intermittent	k mm	k mm	k mm	
036510	XR 2 HD	0.2-2 N.m	1/8	5000	11000	116	56.0	68.0	0.21
036520	XR 5 HD	0.5-5 N.m	1/4	5000	11000	116	56.0	68.0	0.21
036530	XR 20 HD	2-20 N.m	1/2	5000	11000	116	56.0	68.0	0.21
036540	XR 20 SD	2-20 N.m	1/4	5000	11000	71.5	56.0	71.5	0.20
036550	XR 75 SD	7.5-75 N.m	3/8	2500	10000	77.0	56.0	74.0	0.24
036560	XR 180 SD	18-180 N.m	1/2	2500	7600	87.0	58.0	82.5	0.43
036570	XR 500 SD	50-500 N.m	3/4	2000	5000	106	60.0	93.5	0.78
036580	XR 1400 SD	140-1400 N.m	1	1000	4400	125	64.5	104	1.50



Calibrate your Sensors... visit www.torqueleader.com for more details about our on site UKAS (United Kingdom Accreditation Service) Calibration Laboratory

ET-cal II Compact Torque Calibration Analysers

Torque range from 0.1 to 17 N.m

Portable Hand and Power Tool Analysers with multiple units of measurement and test modes

Want to know how to use this tool?



Watch our video



ET-cal II

Can be used for calibrating Electric Torque Screwdrivers for details...see pages 18-19

To download detailed Product Card go to www.torqueleader.com



Key Benefits

- These Analysers are designed to monitor Torque Tool performance. Their high accuracy of +/- 1% of reading together with the supplied PC software make them perfect for testing, storing and analysing tool data
- The flexible design minimises investment, as the ET-cal II are designed to calibrate a wide range of Torque Tools including both Power and Hand tools
- These Analysers enable users to become proficient swiftly by minimising product training times due to their ease of use
- Minimises tool recalibration timescales as the ET-cal II are portable. Being either battery or mains powered together with the onboard memory allowing the Torque Tools to be calibrated at point of use

Order now... call our Sales Hotline +44 (0) 1483 894 476

Order Code	Model	← Calibrated Range →		Drive	kg
		ISO	Imperial		
035270	ET-cal 1	0.1-1 N.m	0.8-8.8 lbf-in	1/2" + 1/4"	2.00
035280	ET-cal 5	0.5-5 N.m	4.4-44 lbf-in	1/2" + 1/4"	2.00
035290	ET-cal 10	1-10 N.m	8.8-88 lbf-in	1/2" + 1/4"	2.00
035295	ET-cal 17	1.7-17 N.m	15-150 lbf-in	1/2" + 1/4"	2.00



Calibrate your Analyser... visit www.torqueleader.com for more details about our on site UKAS (United Kingdom Accreditation Service) Calibration Laboratory

MTP & MTS Mechanical Torque Testers

Torque range from 0 to 25 N.m

Robust Screwdriver Testers

Want to know how to use this tool?



Watch our video

For testing Torque Screwdrivers.
See our ranges on pages 7, 13-17 & 20-23 or visit
www.torqueleader.com



Key Benefits

- The MTS Testers are designed to quickly give confidence that your Torque Tools are operating within limits. The easy to read dial, peak torque and limit pointers all work together to give the operator instant confirmation of tool performance
- Able to operate in a wide variety of environments and situations from shop floor to field operations as the MTS and MTP have no requirement for power
- These Analysers are perfect for use by operators of any skill level as the robust design eliminates the fear of damage caused by overloading

Order now... call our Sales Hotline +44 (0) 1483 894 476

Order Code	Model	Calibrated Range				Drive	kg	Accuracy
		ISO	Imperial	Imperial	Imperial			
058100	MTP 10	0-10 cN.m	0.5 cN.m	0-14 ozf-in	1 ozf-in	1/4	0.98	+/- 2%
058110	MTS 35	7-35 cN.m	0.5 cN.m	10-50 ozf-in	0.5 ozf-in	1/4 + 1/4	3.20	+/- 2%
058120	MTS 130	26-130 cN.m	2 cN.m	36-180 ozf-in	2 ozf-in	1/4 + 1/4	3.20	+/- 2%
058130	MTS 400	0.8-4 N.m	0.05 N.m	7-36 lbf-in	0.5 lbf-in	1/4 + 1/4	3.20	+/- 2%
058140	MTS 1200	2.4-12 N.m	0.2 N.m	24-120 lbf-in	2 lbf-in	1/4 + 3/8	3.20	+/- 2%
058150	MTS 2500	5-25 N.m	0.5 N.m	44-220 lbf-in	5 lbf-in	1/4 + 3/8	3.20	+/- 2%



Calibrate your Analyser... visit www.torqueleader.com for more details about our on site UKAS (United Kingdom Accreditation Service) Calibration Laboratory

QTC Torque Calibration Analysers

Torque range from 0.2 to 3000 N.m

Robust accurate Analysers ideal for rapid hand tool testing

Want to know how to use this tool?



Watch our video

For more information on the QTC Analyser Range visit www.torqueleader.com



QTC 55



QTC 12

Key Benefits

- ▶ Easy to use, robust Workshop Analysers providing +/- 1% accuracy at a competitive price compared to traditional Mechanical Analysers
- ▶ Data management capability via a RS 232 output that allows data to be exported to Microsoft Excel®
- ▶ Versatile Analysers offering Torque Tool checking with four models available covering a range from 0.2 to 3000 N.m
- ▶ Long service life ensured by a simple lightweight design backed up by a full Aftersale and Recalibration Service

Order now... call our Sales Hotline +44 (0) 1483 894 476

Order Code	Model	← Calibrated Range →				Drive	kg	Accuracy
		ISO	Resolution	Imperial	Resolution			
035205	QTC 12	0.2-12 N.m	0.001 N.m	1.8-106 lbf-in	0.001 lbf-in	$\sqrt{A} + \sqrt{A} + \frac{3}{8}$	2.60	+/- 1%
035220	QTC 55	0.9-55 N.m	0.01 N.m	0.7-40 lbf-ft	0.01 lbf-ft	$\frac{1}{4} + \frac{3}{8}$	2.60	+/- 1%
035210	QTC 320	9-320 N.m	0.1 N.m	7-236 lbf-ft	0.1 lbf-ft	$\frac{3}{8} + \frac{1}{2}$	2.60	+/- 1%
035230	QTC 1100	90-1100 N.m	1 N.m	66-811 lbf-ft	1 lbf-ft	$\frac{1}{2} + \frac{3}{4}$	10.0	+/- 1%
035240	QTC 3000	500-3000 N.m	1 N.m	369-2214 lbf-ft	144 lbf-ft	1"	26.0	+/- 1%



Calibrate your Analyser... visit www.torqueleader.com for more details about our on site UKAS (United Kingdom Accreditation Service) Calibration Laboratory

ISO 1500/90° & ISO-A Torque Loading Systems

Eliminates the human element from testing

Want to know how to use this tool?



Watch our video



ISO 1500/90° Torque Loading System

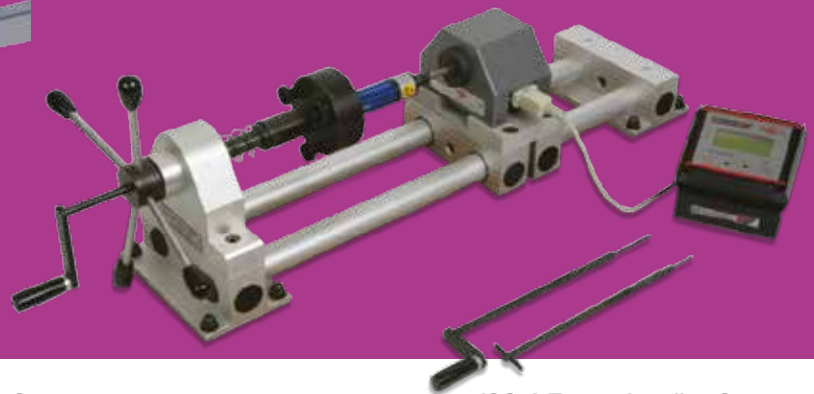

ISO-A Torque Loading System

Key Benefits

- Calibration of Torque Wrenches made easy with our versatile and precise ISO Torque Loading Systems which minimise the possibility of human error
- 1400:1 Gearbox requires low operator effort, therefore torques as high as 1500 N.m can be achieved with ease
- Adaptable and easy adjustment system to suit the individual Torque Wrench being calibrated
- Meets the International Standard ISO 6789:2003 for the calibration of Torque Wrenches

Order now... call our Sales Hotline +44 (0) 1483 894 476

Order Code	Model	← Maximum Capacity →		Maximum Tool Length	
		ISO	Imperial	mm	kg
014300	ISO 1500/90° Torque Loading System	1500 N.m	1107 lbf.ft	1350	32.0
014400	Torque Master ISO-A Torque Loading System	30 N.m	22 lbf.ft	300	8.75
D18204	ET-cal 15 Mounting Kit	30 N.m	22 lbf.ft	300	1.60
D18205	Capture Sensor & ET-cal Compact ISO-A Mount	30 N.m	22 lbf.ft	300	3.40
036771	Capture Sensor ISO 1500/90° Adaptor	1500 N.m	1107 lbf.ft	-	2.60



Need one of our Technical Managers to visit you to demonstrate these Torque Loading Systems in more detail... call now on +44 (0) 1483 894 476

Torqueleader's Calibration Service

Regular calibration is vital to ensure

- ✓ Torque equipment operates to peak performance
- ✓ Guaranteed results
- ✓ Traceability to National and International Standards

“Here at Torqueleader we offer both UKAS and In House Calibration Services...”



0632

UKAS Calibration

Our Calibration Laboratory, accredited by UKAS to ISO/IEC 17025:2005 offers a more in depth Torque Calibration Service. This provides:

- Torque Wrench calibration to ISO 6789:2003
- Torque Sensor calibration to BS 7882:2008
- As found and As left Calibration Certificates
- UKAS Scope 0.2 - 3000 N.m

In addition the technical competence of the Laboratory and its staff have been independently accredited by UKAS.

In House Calibration

Our in house calibration is a cost effective method to ensure your equipment is in peak condition.

This provides:

- Torqueleader's Calibration Certificates
- Clear results
- Traceability to National Standards

Discuss your Calibration needs with us on
+44 (0) 1483 894 476



Introduction to Special Torque Tool Projects

- Meets your exacting demands enabling your torque application to be completed successfully
- Combines Torqueleader's innovative expert engineering designs with our quality core product range to provide bespoke tools



In this section...

- Custom Tool Kit Designs
- Tailor-made Torque Screwdrivers and Wrenches
- Private Label Torque Tools

Custom Tool Kit Designs

Call **+44 (0) 1483 894 476** to discuss

Tailor made to meet your application needs

Want to know
more about us?



Watch our video



Key Benefits

- A wide range of Tool Kit needs can be met using Torqueleader's Custom Design Service
- Tool Kit versatility can be ensured by the use of a mixture of Torqueleader and outsourced tools to meet your particular specification
- To meet operational needs, Tool Kits can be supplied in bespoke tool cases and foam cut outs. These can range from standard design for use in normal working environments to high performance cases for use in harsh operational conditions



Our After Care Calibration Service will keep your bespoke Tool Kit performing accurately and consistently... download the **Service Form** from www.torqueleader.com

Custom Torque Tool Designs

Call **+44 (0) 1483 894 476** to discuss

Tools to overcome specific operational needs

Want to know how to use this tool?



Watch our video



TSN 55 in Stainless Steel

Modification of a TBN

Key Benefits

- To meet the wide range of performance criteria required from the modern Torque Tool, Torqueleader can offer a full design service to match your operational requirements with a range of innovative tool designs and appropriate materials
- Operational integrity is ensured by the tried and tested Torqueleader tool designs and technology to produce bespoke engineering solutions

Modification of a TBN for NATO



Modification of RTU for Track Bolt Tightening



Need one of our Technical Managers to visit you to discuss your customised Torque Tool specification in more detail... call now on **+44 (0) 1483 894 476**

Private Label Torque Tools

Call **+44 (0)1483 894 476** to discuss

Your Company branding on our quality Torque Tools

Want to know how to use this tool?



Watch our video



Private Label of an Ergo Quickset Adjustable Torque Screwdriver

Key Benefits

- ▶ A full Design Service is available for custom label tools that use a variety of materials, components design, tool labelling and custom tool certification
- ▶ Cost effective own branding has been made easier by the use of our modern 3D CAD Systems, laser engraving machines and custom label manufacturing technology



Private Branding of an ADS Dial Wrench

TSN Wrench Private Branding

Tool Selector

Use our Tool Selector at www.torqueleader.com/tool-selector to select the right tool for your application, then tell us your branding requirements on **+44 (0) 1483 894 476**

Introduction to Additional Torque Products

- Wide range of Accessories which are compatible with our Torque Tools
- Obtain everything you need from one source



In this section...

- Torque Wrench End Fittings, Adaptors and Sockets
- Torque Screwdriver Accessories and Additional Torque Products
- For Accessories not in our standard range contact us on **+44 (0) 1483 894 476**



Torque Wrench End Fittings

Captive Pin Type

Metric & Imperial Accessories compatible with TBN 2 & 10

Learn more about our tools on...



Watch our videos



Open End



Ring End

* Ring End supplied as bi-hex or 6pt hex



Flared End



Setting Adaptor

For information on the TBN 2 & 10 see pages 30-31 or visit www.torqueleader.com

1/4" SD for use with Calibration Analysers

Order now... call our Sales Hotline +44 (0)1483 894 476

Metric							
Order code A/F	Order code Open End	Order code A/F	Order code Ring End *	Order code A/F	Order code Flared End	Order code A/F	Order code Setting Adaptor
3.2	012000	3.2	012250	3.2	-	3.2	012750
4	012005	4	012255	4	-	4	012755
5	012010	5	012260	5	-	5	012760
5.5	012015	5.5	012265	5.5	-	5.5	012765
6	012020	6	012270	6	-	6	012770
7	012025	7	012275	7	-	7	012775
8	012030	8	012280	8	012505	8	012780
9	012035	9	012285	9	012510	9	012785
10	012040	10	012290	10	012515	10	012790
11	012045	11	012295	11	012520	11	012795
12	012050	12	012300	12	012525	12	012800
13	012055	13	012305	13	012530	13	012805
14	012060	14	012310	14	012535	14	012810
15	012065	15	012315	15	012540	15	012815
16	012070	16	012320	16	012545	16	012820
17	012075	17	012325	17	012550	17	012825
18	012080	18	012330	18	-	18	012830
19	012085	19	012335	19	012555	19	012835
20	012090	20	012340	20	-	20	012840
21	012095	21	012345	21	-	21	012845
22	012100	22	012350	22	012560	22	012850
23	012105	23	012355	23	-	23	012855
24	012110	24	012360	24	012565	24	012860
25	012115	25	012365	25	-	25	012865

Imperial							
Order code A/F	Order code Open End	Order code A/F	Order code Ring End *	Order code A/F	Order code Flared End	Order code A/F	Order code Setting Adaptor
5/32	012150	5/32	012400	5/32	-	5/32	012875
3/16	012155	3/16	012405	3/16	-	3/16	012880
7/32	012160	7/32	012410	7/32	-	7/32	012885
1/4	012165	1/4	012415	1/4	012600	1/4	012890
5/16	012175	5/16	012420	5/16	012605	5/16	012900
3/8	012185	3/8	012425	3/8	012610	3/8	012910
7/16	012195	7/16	012430	7/16	012615	7/16	012920
1/2	012200	1/2	012435	1/2	012620	1/2	012925
9/16	012205	9/16	012440	9/16	012625	9/16	012930
5/8	012210	5/8	012445	5/8	012630	5/8	012935
11/16	012215	11/16	012450	11/16	-	11/16	012940
3/4	012220	3/4	012455	3/4	012635	3/4	012945
13/16	012225	13/16	012460	13/16	-	13/16	012950
7/8	012230	7/8	012465	7/8	012640	7/8	012955
15/16	012235	15/16	012470	15/16	-	15/16	012960
1	012240	1	012475	1	012645	1	012965

To convert TBN 2 & 10 to 1/4" Square Drive

Type	Order code	Centre [mm]
1/4 Fixed	A36340	27
1/4 Ratchet	A73640	27



Hex Key Setting Adaptors

Order code	Hex Key Sizes A/F
A45271	1.0 - 2.5 mm
A45272	3.0 - 5.0 mm
A45273	6.0 - 8.0 mm



Hex Key Adaptors

Order code	Hex Key Sizes [mm]
A37610	1.0 - 2.5
A37620	3.0 - 5.0
A38350	6.0 - 8.0



Blank End

For making up Specials
Material 070M20 (EN3B)

Order code	Centre [mm]
A64440	12
A64450	34



Need help selecting a specific End Fitting for your tool... contact our Sales Team now on +44 (0)1483 894 476 or email salesandrepairs@torqueleader.co.uk

Torque Wrench End Fittings

8 mm Spigot Type

Metric & Imperial Accessories compatible with ATB 2.5, 5 & 10

Want to know how to use this tool?



Watch our video



Open End



Ring End

* Ring End supplied as bi-hex or 6pt hex



Flared End

For information on the ATB 2.5, 5 & 10 see pages 34-35 or visit www.torqueleader.com

Order now... call our Sales Hotline +44 (0) 1483 894 476

Metric							
A/F	Order Code	A/F	Order Code	A/F	Order Code	A/F	Order Code
	Open End		Ring End *		Flared End		Set With
3.2	049000	3.2	049250	3.2	-	3.2	A29071
4	049005	4	049255	4	-	4	A29071
5	049010	5	049260	5	-	5	A29071
5.5	049015	5.5	049265	5.5	-	5.5	A29071
6	049020	6	049270	6	-	6	A29071
7	049025	7	049275	7	-	7	A29071
8	049030	8	049280	8	049505	8	A29071
9	049035	9	049285	9	049510	9	A29071
10	049040	10	049290	10	049515	10	A29071
11	049045	11	049295	11	049520	11	A29071
12	049050	12	049300	12	049525	12	A29071
13	049055	13	049305	13	049530	13	A29071
14	049060	14	049310	14	049535	14	A29071
15	049065	15	049315	15	049540	15	A29071
16	049070	16	049320	16	049545	16	A29071
17	049075	17	049325	17	049550	17	A29071
18	049080	18	049330	18	-	18	A29071
19	049085	19	049335	19	049555	19	A29071
20	049090	20	049340	20	-	20	A29071
21	049095	21	049345	21	-	21	A29071
22	049100	22	049350	22	049560	22	A29071
23	049105	23	049355	23	-	23	A29071
24	049110	24	049360	24	049565	24	A29071
25	049115	25	049365	25	-	25	A29071

Imperial							
A/F	Order Code	A/F	Order Code	A/F	Order Code	A/F	Order Code
	Open End		Ring End *		Flared End		Set With
5/32	049150	5/32	049400	5/32	-	5/32	A29071
3/16	049155	3/16	049405	3/16	-	3/16	A29071
7/32	049160	7/32	049410	7/32	-	7/32	A29071
1/4	049165	1/4	049415	1/4	049600	1/4	A29071
5/16	049175	5/16	049420	5/16	049605	5/16	A29071
3/8	049185	3/8	049425	3/8	049610	3/8	A29071
7/16	049195	7/16	049430	7/16	049615	7/16	A29071
1/2	049200	1/2	049435	1/2	049620	1/2	A29071
9/16	049205	9/16	049440	9/16	049625	9/16	A29071
5/8	049210	5/8	049445	5/8	049630	5/8	A29071
11/16	049215	11/16	049450	11/16	-	11/16	A29071
3/4	049220	3/4	049455	3/4	049635	3/4	A29071
13/16	049225	13/16	049460	13/16	-	13/16	A29071
7/8	049230	7/8	049465	7/8	049640	7/8	A29071
15/16	049235	15/16	049470	15/16	-	15/16	A29071
1	049240	1	049475	1	049645	1	A29071

To convert 8mm Spigot to 1/4" Square Drive

Type	Order Code	Centre kmm
1/4 Fixed	A29071	25

Type	Order Code	Centre kmm
1/4 Ratchet	A28990	25



Need help selecting a specific End Fitting for your tool... contact our Sales Team now on +44 (0) 1483 894 476 or email salesandrepairs@torqueleader.co.uk

Torque Wrench End Fittings

16 mm Spigot Type

Metric & Imperial Accessories compatible with
ATB 25, 50 & 100, TBN 25, 65, 135 & 200, TCS & TCP Ranges

Want to know how to use this tool?



Watch our video



Open End

Ring End

Flared End



Blank End Fitting
16 mm Spigot Type
Order Code: A55230

Available to customers wishing to make special spanner end attachments



Square Drive
16 mm Spigot Type
Order Code:
 $\frac{3}{8}$ " - 029040
 $\frac{1}{2}$ " - 029060



Ratchet Head
Square Drive
16 mm Spigot Type
Order Code:
 $\frac{3}{8}$ " - 029010
 $\frac{1}{2}$ " - 029030

Order now... call our Sales Hotline +44 (0) 1483 894 476

Metric					
A/F	Order Code	A/F	Order Code	A/F	Order Code
	Open End		Ring End		Flared End
7	026020	7	027220	7	028190
8	026040	8	027240	8	028200
9	026060	9	027260	9	028210
10	026080	10	027280	10	028220
11	026100	11	027300	11	028240
12	026120	12	027320	12	028260
13	026140	13	027340	13	028280
14	026160	14	027360	14	028300
15	026180	15	027380	15	028320
16	026200	16	027400	16	028340
17	026220	17	027420	17	028360
18	026240	18	027440	18	028380
19	026260	19	027460	19	028400
20	026280	20	027480	20	028420
21	026300	21	027500	21	028440
22	026320	22	027520	22	028460
23	026340	23	027540	23	028480
24	026360	24	027560	24	028500
25	026380	25	-	25	-
26	026400	26	027600	26	-
27	026420	27	027620	27	028520
30	026440	30	-	30	-
32	026460	32	-	32	-

Imperial					
A/F	Order Code	A/F	Order Code	A/F	Order Code
	Open End		Ring End		Flared End
$\frac{5}{16}$	026620	$\frac{5}{16}$	027720	$\frac{5}{16}$	-
$\frac{3}{8}$	026640	$\frac{3}{8}$	027740	$\frac{3}{8}$	028600
$\frac{7}{16}$	026650	$\frac{7}{16}$	027750	$\frac{7}{16}$	028620
$\frac{1}{2}$	026660	$\frac{1}{2}$	027760	$\frac{1}{2}$	028640
$\frac{9}{16}$	026680	$\frac{9}{16}$	027780	$\frac{9}{16}$	028660
$\frac{5}{8}$	026690	$\frac{5}{8}$	027790	$\frac{5}{8}$	028680
$\frac{11}{16}$	026700	$\frac{11}{16}$	027800	$\frac{11}{16}$	028700
$\frac{3}{4}$	026710	$\frac{3}{4}$	027810	$\frac{3}{4}$	028710
$\frac{13}{16}$	026720	$\frac{13}{16}$	027820	$\frac{13}{16}$	028720
$\frac{7}{8}$	026740	$\frac{7}{8}$	027840	$\frac{7}{8}$	028740
$\frac{15}{16}$	026750	$\frac{15}{16}$	027850	$\frac{15}{16}$	028750
1	026760	1	027860	1	028760
$1\frac{1}{16}$	026770	$1\frac{1}{16}$	027880	$1\frac{1}{16}$	028770
$1\frac{1}{8}$	026780	$1\frac{1}{8}$	-	$1\frac{1}{8}$	028780
$1\frac{3}{16}$	026800	$1\frac{3}{16}$	027920	$1\frac{3}{16}$	028800
$1\frac{1}{4}$	026820	$1\frac{1}{4}$	-	$1\frac{1}{4}$	-

Hex Key Adaptors



Order Code	Hex Key Sizes k mm
A38940	2.5-5.0
A38950	6.0-8.0



Need help selecting a specific End Fitting for your tool... contact our Sales Team now on +44 (0) 1483 894 476 or email salesandrepairs@torqueleader.co.uk

Hexagon Nut Sockets

Order now call... **+44 (0) 1483 894 476**

Metric & Imperial Accessories to complement
Standard and Insulated Wrenches

Want to know how
to use this tool?



Watch our video

For information on all
our Torque Tools visit
www.torqueleader.com



1/4" Square Drive Hexagon Nut Sockets

Metric			Imperial			Imperial		
Type	Order Code	A/F	Type	Order Code	A/F	Type	Order Code	A/F
NS 4	030500	4	NS 8BA	031100	.152	NS 187	030800	3/16
NS 4.5	030520	4.5	NS 7BA	031120	.172	NS 219	030820	7/32
NS 5	030540	5	NS 6BA	031140	.193	NS 234	030840	15/64
NS 5.5	030560	5.5	NS 5BA	031160	.220	NS 250	030860	1/4
NS 6	030580	6	NS 4BA	031180	.248	NS 266	030880	7/64
NS 7	030600	7	NS 3BA	031200	.282	NS 281	030900	9/32
NS 8	030620	8	NS 2BA	031220	.324	NS 312	030920	5/16
NS 9	030640	9	NS 1BA	031240	.365	NS 344	030940	11/32
NS 10	030660	10	NS 0BA	031260	.413	NS 375	030960	3/8
NS 11	030680	11	-	-	-	NS 437	030980	7/16
NS 12	030700	12	-	-	-	NS 500	031000	1/2
NS 13	030720	13	-	-	-	-	-	-
NS 14	030740	14	-	-	-	-	-	-

Metric Insulated Nut Sockets

50V for Low Voltage Applications	
A/F	Order Code 1/4" in Drive
8	030620A11030
10	030660A11030
11	-
12	030700A11030
13	030720A11030
14	030740A11030
16	-
17	-
18	-



Need help selecting a specific Socket or Adaptor for your tool... contact our Sales Team
now on **+44 (0) 1483 894 476** or email salesandrepairs@torqueleader.co.uk

Screwdriver Accessories

Order now call... **+44 (0) 1483 894 476**

Accessories to complement Screwdrivers

Want to know how to use this tool?



Watch our video

See our range of Screwdrivers on pages 7, 13-23 or visit www.torqueleader.com



Blade



Pozidriv



Phillips



Torx

1/4" A/F Hexagon Shank Bits & Blades for use with all 1/4" FH Screwdrivers

Blade				Pozidriv				Phillips				Torx			
Type	Order Code	Size	k mm	Type	Order Code	Size	k mm	Type	Order Code	Size	k mm	Type	Order Code	Size	k mm
3	029300	3 mm x 0.5	39	No. 0	029500	No. 0	25	No. 0	029600	No. 0	25	TX6	029740	1.65	25
4.5	029320	4.5 mm x 0.6	39	No. 1	029520	No. 1	50	No. 1	029610	No. 1	50	TX8	029760	2.28	25
5.5	029340	5.5 mm x 0.8	39	No. 2	029540	No. 2	50	No. 2	029620	No. 2	50	TX10	029770	2.72	25
6.5	029360	6.5 mm x 1.2	39	No. 3	029560	No. 3	50	No. 3	029640	No. 3	50	TX20	029780	3.84	25
8	029380	8 mm x 1.6	39	-	-	-	-	-	-	-	-	TX25	029790	4.39	25



Blade



Pozidriv



Phillips



Torx

Torque Power Bits for use with ESD Electric Torque Screwdrivers

Blade			Pozidriv			Phillips			Torx		
Type	Order Code	k mm	Type	Order Code	k mm	Type	Order Code	k mm	Type	Order Code	k mm
3 x 0.5	029305	50	No. 0	029505	50	No. 0	029605	50	TX06	029745	50
4 x 0.5	029325	50	No. 1	029525	50	No. 1	029615	50	TX08	029765	50
5.5 x 0.8	029345	50	No. 2	029545	50	No. 2	029625	50	TX10	029775	50
6.5 x 1.2	029361	50	No. 3	029565	50	No. 3	029645	50	TX20	029785	50

Lock On T-Bar

- Extra leverage provided with removable T-Bar for larger screwdriver models
- Accidental tool disengagement is prevented through the Lock On feature

Order Code: P29530

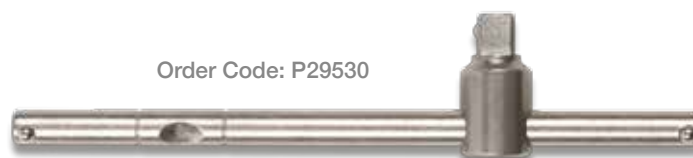

Need help selecting a specific Accessory for your tool... contact our Sales Team now on **+44 (0) 1483 894 476** or email salesandrepairs@torqueleader.co.uk

Screwdriver Accessories

Order now call... **+44 (0) 1483 894 476**

Accessories to complement Screwdrivers

Want to know how to use this tool?



Watch our video

Converters & Adaptors

Type	Order Code	← To Convert Tool Drive →		mm
		From	To	
FSHA	A35640			30 (1 1/4")
Converter	029200			50 (2")
MSHA	A25420			25



FSHA



Converter



MSHA

Inline Freewheel Adaptor

For use with 1/4" FH Screwdrivers			
Model	Order Code	Torque	Freewheel
FWA-R	A8842R	Clockwise	Anticlockwise
FWA-L	A8842L	Anticlockwise	Clockwise



- Absorbs unwanted shock loads by transmitting torque in one direction and freewheeling in the opposite direction
- Roller clutch for minimal backlash and drag

Special Crowsfoot Spanner Ends

Order Code	A/F Size
C62890	3/8 in
C62891	1/2 in
C62892	8 mm
C62893	14 mm
C62894	18 mm
C62895	5 mm
C62896	1/4 in
C62897	19 mm
C62898	6 mm



Need help selecting a specific Accessory for your tool... contact our Sales Team now on **+44 (0) 1483 894 476** or email salesandrepairs@torqueleader.co.uk

Convertors and Adaptors

Order now call... **+44 (0) 1483 894 476**

Accessories to complement Screwdrivers and Wrenches

Want to know how to use this tool?



Watch our video

Socket Blanks

For manufacturing Special Extensions for use with Square Drive Tools Material 817M40 (EN24)

Type	Order Code	Metric Dimensions		
		A	B	C
SB2	A15720	1/4	5/8	7/8
SB3	A16200	3/8	7/16	1 1/8
SB4	A16210	1/2	1	1 1/4
SB5	A14790	3/4	1 1/2	2 5/16
SB6	A14800	1	2	2 9/16



Converters

Type	Order Code	To Convert Tool Drive	
		From	To
DSAP	031320	1/4	3/8
DPAS	031300	3/8	1/4
ASEP	031340	3/8	1/2
APES	031360	1/2	3/8
ESHP	031380	1/2	3/4
EPHS	031400	3/4	1/2
HSGP	031420	3/4	1"
HPGS	031440	1"	3/4



Hexagon Key Bits

Metric				Imperial				Imperial			
Type	Order Code	A/F	⟨mm⟩	Type	Order Code	A/F	⟨mm⟩	Type	Order Code	A/F	⟨mm⟩
IB 1.5	030100	1.5	25	IB 093	030300	3/32	25	G2	B1607A	.035	35
IB 2	030120	2	25	IB 109	030310	7/64	25	G3	B1607B	.050	35
IB 2.5	030140	2.5	25	IB 125	030320	1/8	25	G4	B1607C	.062	35
IB 3	030160	3	25	IB 141	030330	9/64	25	G5	B1607D	5/64	35
IB 4	030180	4	25	IB 156	030340	5/32	25	-	-	-	-
IB 5	030200	5	25	IB 187	030360	3/16	25	-	-	-	-
IB 6	030220	6	25	IB 281	030380	7/32	25	-	-	-	-
IB 7	030240	7	25	IB 250	030400	1/4	25	-	-	-	-
IB 8	030260	8	25	IB 312	030410	5/16	25	-	-	-	-

Note: IB Bits will require 1/4" FSHA Adaptor unless your tool is already a 1/4" FH Drive



Integral 1/4" Square Drive



Need help selecting a specific Socket or Adaptor for your tool...contact our Sales Team now on **+44 (0) 1483 894 476** or email salesandrepairs@torqueleader.co.uk

Additional Torque Products

Order now call... **+44 (0) 1483 894 476**

Accessories to complement Screwdrivers & Wrenches

Want to know how to use this tool?



Watch our video



Hanging Loop End Caps

Order Code:

B34872 for TBN 2 & 10, TSP 5 & 10

B34882 for TBN 25 & TSN 25

B34892 for TSN 55

B34902 for TSN 125, TBN 65 & 135



For details on our Switch Operated Signal Torque Wrenches (Sw) range see pages 28-29 or visit www.torqueleader.com

Hanging Loops

Order Code:

B37582 for Signal Output Tools (Sw)

Hanging Loops

- The Hanging Loop End Caps are designed for use with TSN, TSP and TBN wrenches and Hanging Loops for use with Signal Output tools
- Enables tools to be used with a lanyard or tool balance

PVC Grips

- Easy to fit PVC designed to improve user comfort and grip
- Tool colour coding, serial numbers and recalibration dates can be seen clearly through the transparent grips
- Up to 50% less operator effort in applying same torque
- Lubricant P.80 100ml available for easy fitting of grips (Order Code: **A90220**)



Order Code:

P19030 Minor Grip

P19040 Standard Grip

TSN Head Covers

- Protects the work piece from accidental damage from the tool during use
- The TSN Head Covers protect and fit the heads of the TSN range of wrenches
- Ideal for Production areas where easily damaged materials are used



Order Code:

A29420 for TSN 25

B28080 for TSN 55

B28090 for TSN 125



Cannot find what you are looking for... contact our Sales Team now on **+44 (0) 1483 894 476** or email salesandrepairs@torqueleader.co.uk

Special Extension Spanners & Adaptors

To apply Torque in awkward spaces

Accessories to complement the Dial Measuring Wrench Range

Want to know how to use this tool?



Watch our video

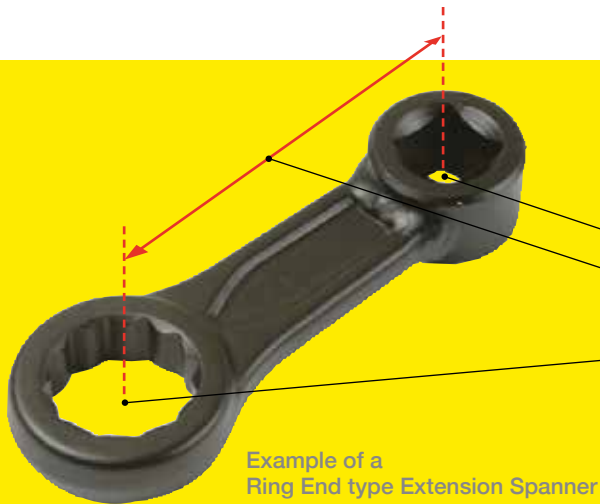

Example of a Ring End type Extension Spanner

Where there are space limitations when using Dial Wrenches we can manufacture Special Extension Spanners for you.

To order please supply the following information:

- Square drive size
- Centred distance between the square drive and the spanner end fitting
- A/F size of spanner end
- End type - Ring, Open or Flared
- Maximum Torque to be applied
- A fully dimensioned drawing

How to Calculate the True Torque when using Extension Spanners

When using Extension Spanners the dial reading will not display the correct torque being applied. To ensure **True Torque** see the formula on the right to recalculate

$$\frac{DR \times (E + L)}{L} = \text{True Torque}$$

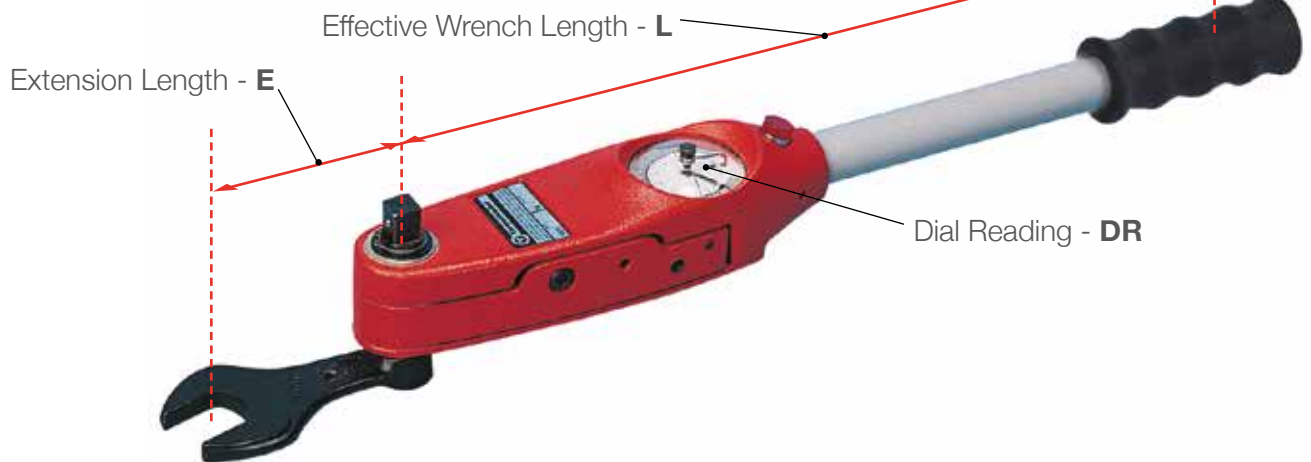

Table of Effective Wrench Lengths across our Range

Model Ranges	Effective Length (mm)
ADS 12/25/40	190
BDS 80	368
BDS 160/200	445
CDS	635
DDS	850
EDS	1727

Special Extension Spanners are not recommended for ADS 4 & 8 due to high accuracy at low torque ranges

Extension Adaptors for ADS & BDS Wrenches where space is restricted

Adaptor Model	Order Code	Drive
16mm Spigot	A96102	3/8"
	A96103	1/2"
German 9x12 Cavity Fitting	A96112	3/8"
	A96113	1/2"
Wedge Fitting	A96122	3/8"
	A96123	1/2"

Measure dimension of Adaptor & End Fitting for E (see diagram above)



Need help selecting the right Extension Spanner for your tool... contact our Sales Team now on **+44 (0) 1483 894 476** or email salesandrepairs@torqueleader.co.uk

Introduction to Technical Support

- Information on our Services, Quality Assurance and Standards
- Guide to calculating correct torque settings



In this section...

- About Us and Our Distributors
- Calibration Service, Quality and Standards
- Explanation of Torque Information and Factors



About Us & Our Distributors

Commitment to Quality of Service

Innovation | Precision | Performance | Solution | Quality

Want to know
more about us?

You Tube

Watch our video



TAKING THE RISK OUT OF TIGHTENING

We are worldwide...

51 Countries

74 Distributors

For more details visit...

www.torqueleader.com

Making the Right Choice...

- For over 75 years we have been instrumental in the design, manufacture and assembly of Torque Tools in the United Kingdom utilising the latest technology that include our unique slipping and breaking mechanisms
- Our tools, which Measure, Apply and Calibrate, are used worldwide and are suitable for a variety of applications in Manufacturing, Quality Control, Maintenance and Repair across many Industries such as Automotive, Aerospace, Electronics and Military
- We are a partner of the Gedore Group. This enables us to have the strength of resources to invest for the future ensuring continued customer satisfaction
- We are committed to providing excellent customer service. Torqueleader's products are available and supported throughout the world where our Distributors are factory trained to give a full service and are able to recommend the best products to meet customers' requirements

Sales contact details...

Tannery Lane, Gosden Common, Bramley,
Guildford, Surrey GU5 0AJ

Phone: +44 (0) 1483 894 476

Fax: +44 (0) 1483 898 536

Email: salesandrepairs@torqueleader.co.uk



We are committed to working in partnership with all of our customers to create long lasting relationships... talk to our dedicated team on **+44 (0) 1483 894 476**

Taking Care of Your Tools

Calibration, Servicing & Repair

Our **on site** UKAS Accredited Calibration Laboratory

Want to know how to use this tool?



Watch our video



UKAS Calibration of a Torque Wrench



Servicing of a Torque Screwdriver

For more details on our In House or UKAS Calibration & After Sales Services visit...

www.torqueleader.com



0632

Key Service Information

- We calibrate most Hand Torque Tools, Analysers and Sensors in accordance with the International Standards in our on site UKAS Accredited Calibration Laboratory
- Our tools contain moving parts that require periodic servicing and lubrication - recommended service interval of twelve months, or more frequent if high usage. If you choose to do your own servicing, the following lubrication tables give details of the recommended oils and greases as used in our tools

Tool Lubrication Table For Torqueleader Products

Torque Wrenches	Lubricants - Correct at time of going to print								
	Fuchs Renolit CX1 2 Grease	Total Multis MS 2	Fuchs Renolit EP X1 PBF	Total Multis EP2	Silicon Grease RS 555-083	Shell Tonna 32 Lubricating Oil	Rocol Dry Moly Paste (ASP)	Amalgam of 75% Dry Moly Paste 25% Lubricating Oil	CX HT2 Grease
Dial Wrenches	ADS Ratchet & Pawl			BDS/CDS/DDS Ratchet & Pawl	Window Assembly 'O' Rings				
STB			Spring, Cam & Roller			Ratchet & Pawl			
TSC & TSP	Bearings, TSC Locking Mechanism						Thrust Pin		
TSN			Spring, Cam & Roller		'O' Rings	Ratchet & Pawl			
TBN 2 & 10		Spring				Adj. Screw			
TBN 25,65,135 & 200		Spring					Roller, Cam, Thrust Pad, Captive Pin		
ATB 5, 10, 25, 50, 100							Roller, Cam, Thrust Pad, Captive Pin	Trunnion, Adj. Screw	
							Adj. Screw, Captive Pin, Int.Spring Adjuster, Lock Knob & Adj. Screw End, Ext. Handle		Spring, Ext. Spring Adjuster, Trunnion, Int. Handle

Torque Screwdrivers & Analysers	Lubricants - Correct at time of going to print						
	Shell Stamina EP2 Grease	Total Multis EP2	Silicon Grease RS 555-083	NYE Rheolube 368 F Strained Grease	WD-40 Lubricant/Inhibitor	Renolin B3 - VG10	All Purpose 3 in 1
TT					Torsion Bars & Spring Clamps		Memory Assembly
Quickset, QSN & QSA	General Use Ball Housing	Handle Threads	'O' Rings				
TLS	General Use Spring Housing						
Cleanroom CRS				General Use Spring Housing			
MTS & MTP						Drive Spindle & Needle Bearings	
ISO 1000 & ISO 1500		Multiplier & Worm Gearbox					



At Torqueleader we constantly strive to keep up to date with the advances in technology and products... for the latest information visit www.torqueleader.com

British & International Standards

Peace of mind through Quality

Ensuring consistency of our products for your application

Want to know how to use this tool?



Watch our video



MHH Engineering Co. Ltd. (Manufacturer of Torqueleader tools) is assessed and registered to **BS EN ISO 9001:2008 Certificate FM 363** Hand Tools and Implements.

All Torqueleader tools are manufactured to the relevant British and International Engineering Standards and conform to the International Standard on Torque Tools **ISO 6789:2003** or as specified.

The International Standard ISO 6789:2003 for Hand Torque Tools states:

- The effective working range of a tool is from 20% to 100% of its maximum torque value
- The accuracy requirements for Torque Screwdrivers are +/- 6% of reading and for Torque Wrenches are +/- 4% of reading or +/- 6% for Torque Wrenches below 10 N.m
- The maximum torque value for each square drive size
- Scale and marking requirements
- An overload ability of 125% of maximum torque capacity
- A calibration interval of 5000 cycles or 12 months
- Test and measuring procedures at 23° +/- 5°C
- The maximum permissible uncertainty of measurement of the calibration device shall be +/-1% of the indicated value

Explanation on Terms

- **Accuracy** of Measuring and Calibrated Scale Tools is their ability to deliver the torque as set on their scale, dial or digital display. This is usually expressed as a percentage of the target torque
- **Resolution** of Measuring and Calibrated Scale Tools is the number of divisions that their full torque range is divided into. This can be displayed as decimal places on a digital display, number of divisions on a dial or graduations on a scale
- **Repeatability** of Preset Tools is the ability to consistently apply the same torque in subsequent tightening operations. This is usually expressed as a percentage of the preset torque.

Explanation on Serial Numbers

- All new and newly reconditioned Torqueleader tools are marked with a serial number which enables **Complete Traceability**. This number is stored together with other data such as the original works order number and calibration details



2	L	H	034407
Model Code	Month Code	Year Code	Consecutive Serial Number
A = January... L = November M = December.		A = 2002... H = 2009 N = 2014	

Tool Selector

Need advice on choosing the right tool for your Torque application... use our Tool Selector at www.torqueleader.com/tool-selector

Certification & Traceability

Why Calibration is Important

Torqueleader meet the rigorous International Standards

Want to know how to use this tool?



Watch our video

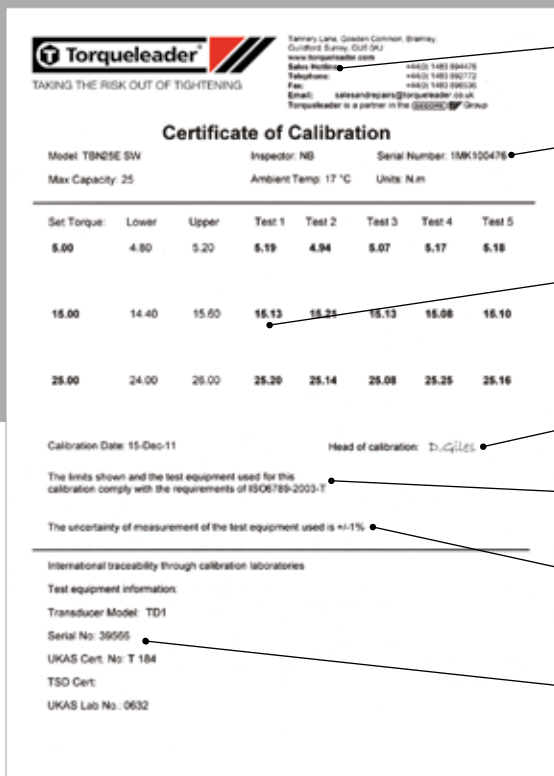

Supplier Section... can be tailored to include our Distributor's name and address

Tool Identification Section... for easy identification of the tool, its maximum capacity and its individual serial number

Test Result Section... gives the normal point at which the tool was tested, the tolerances and the actual results obtained

Certification Section... date and approval signature of test

Standard Section... confirms the standard requirements to which the tool complies

Note Section... gives information regarding slave pointers etc

Traceability Section... the serial numbers of the test equipment and the route back to National Standards

Torqueleader Calibration is Traceable to International Standards

➤ All equipment used by us in the Calibration of Torque Tools is regularly checked to ensure that the results obtained are accurate. All Calibration Equipment is itself assessed using equipment with certification traceable to International Standards as listed below:

➤ For Length/Metre & Weight/Mass:

- Coordinate Measuring Machine
- Transfer Standards held by National Physical Laboratory
- National Physical Laboratory Stabilised Lasers
- National Standard for the Metre*
- Trading Standards Department
- UKAS Accredited Mass Laboratory
- National Measurement Office
- International Bureau of Weights & Measures
Sèvres, Paris

* Defined as the length of the path travelled by light in vacuum during a time interval of 1/299 792 498 of a second

UKAS Accreditation Certificate for Torqueleader's Calibration Laboratory & Personnel



➤ Torqueleader's testing and calibration procedures are performed using equipment traceable to National Standards



Regular Calibration and care of your tools is vital... discuss with us on **+44 (0) 1483 894 476** to find out how we can ensure your tools are kept in prime condition

An Explanation of Torque

Information on Measuring Torque

What you need to know to avoid incorrect tightening

Want to know how to use this tool?



Watch our video

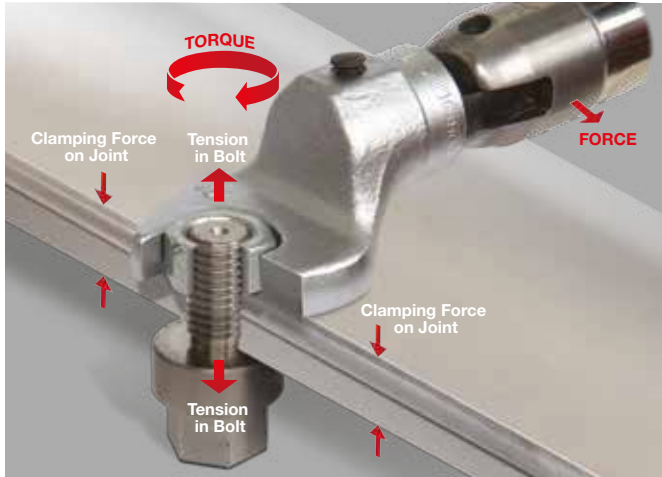

Torque is the application of a **Force** acting at a radial **Distance** and tending to cause rotation. Torque is used to create tension in threaded fasteners.

When the nut and bolt are tightened the two plates are clamped together. The thread converts the applied torque into tension in the bolt shank. This in turn is converted into a clamping force. The amount of tension created in the bolt is critical.

Explanation on the creation of a Clamping Force

- The tension in the bolt creates a clamping force (generally referred to as the preload) between the two parts
- If the clamping force is too low, the fasteners can work loose due to vibration or movement between the component parts
- If a clamping force is too high, the fastener may permanently stretch and no longer apply the required clamping force
- In severe cases the fastener may fail in assembly or during use when under load

Explanation on how Torque is Calculated

- Torque is the result of multiplying the value of **Force** applied by the **Distance** from the point of application
- Comparing the two examples see below (A and B) the same resultant torque can be achieved with a lower Force if the Distance from the nut/bolt is increased
- Some Torque Wrenches are **length dependent** which means that the actual torque applied to the fastener varies if the hand position on the wrench is varied - even with the wrench preset. This occurs if the pivot point of the wrench mechanism is not coincidental with the centre of rotation of the fastener

Force x Distance = Torque (See right)

- Example A: 20 N x 1 m = **20 N.m**
- Example B: 10 N x 2 m = **20 N.m**

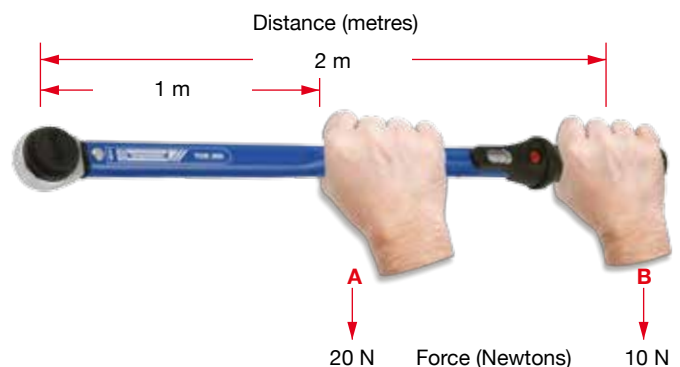

Conversion Factors & Maximum Recommended Tightening Torques

Need help... call us on **+44 (0) 1483 894 476**

Want to know more about us?



Watch our video

Units to be converted	Conversion Factors								
	ISO			Imperial			Metric		
	mN.m	cN.m	N.m	ozf.in	lbf.in	lbf.ft	gf.cm	kgf.cm	kgf.m
1 mN.m	1	0.1	0.001	0.142	0.009	0.0007	10.2	0.01	0.0001
1 cN.m	10	1	0.01	1.416	0.088	0.007	102	0.102	0.001
1 N.m	1000	100	1	141.6	8.851	0.738	10197	10.20	0.102
1 ozf.in	7.062	0.706	0.007	1	0.0625	0.005	72	0.072	0.0007
1 lbf.in	113	11.3	0.113	16	1	0.083	1152.1	1.152	0.0115
1 lbf.ft	1356	135.6	1.356	192	12	1	13826	13.83	0.138
1 gf.cm	0.098	0.01	0.0001	0.014	0.0009	0.00007	1	0.001	0.00001
1 kgf.cm	98.07	9.807	0.098	13.89	0.868	0.072	1000	1	0.01
1 kgf.m	9807	980.7	9.807	1389	86.8	7.233	100000	100	1

Use our online Conversion Table at www.torqueleader.com/knowledge-centre/torque

Thread Diameter (mm)	Hex Sizes			
	Hex Key Size (mm)	Hex Key Size (mm)	Hex Key Size (mm)	Hex Head Size (mm)
M 2	-	1.5	1.27	4
M 2.5	-	2	1.5	5
M 3	2	2.5	2	5.5
M 4	2.5	3	2.5	7
M 5	3	4	3	8
M 6	4	5	4	10
M 7	-	-	-	11
M 8	5	6	5	13
M 10	6	8	6	17
M 12	8	10	8	19
M 14	-	-	-	22
M 16	-	14	10	24
M 18	-	-	-	27
M 20	-	17	12	30
M 22	-	-	-	32
M 24	-	-	-	36
M 27	-	-	-	-

Recommended Tightening Torques N.m		
Bolt Grade 8.8	Bolt Grade 10.9	Bolt Grade 12.9
0.37	0.52	0.63
0.86	1.21	1.45
1.3	1.9	2.3
3.0	4.3	5.1
6.0	8.5	10.2
10.3	14.7	17.9
17.2	24.5	28.4
25.5	35.3	42.2
50.0	70.6	85.3
87.3	123	147
138	194	235
211	299	358
289	412	490
412	579	698
559	785	941
711	1000	1198
1049	1481	1775

Button Head



Cap Head



Countersunk Head



Hex Head Bolt



Torque N.m

These figures are for guidance only. The torque for each application should be calculated taking into account all circumstances that apply to that joint.



Need one of our Technical Managers to visit you to demonstrate a specific tool or discuss your Torque Tool requirement in more detail... call now on **+44 (0) 1483 894 476**



Sales Hotline:

+44 (0) 1483 894 476

Email:

salesandrepairs@torqueleader.co.uk

Switchboard:

+44 (0) 1483 892 772

Facsimile:

+44 (0) 1483 898 536



see pages 13 - 16



www.torqueleader.com

Tannery Lane, Gosden Common, Bramley, Guildford, Surrey GU5 0AJ

Torqueleader is a registered trademark of MHH Engineering Co. Ltd. and is a partner in the GEORGE W Group
All information in this document is correct at time of going to print 06/14.
As part of its continuing development process Torqueleader reserves the right to alter specifications without prior notice.